



# Limited Area Modelling in CRM mode

Peter Clark, ECMWF Seminar, 1-4 September 2008



# Contents

- Why bother? How do we assess high resolution forecasts?
- Surface
- Radiation
- Cloud microphysics
- Turbulence and convection



# Why bother? Why do we want to run forecast models at ~1-2 km resolution.

- NOT to give accurate site-specific forecasts (e.g. thunderstorm over Shinfield at 2.45 pm tomorrow afternoon), though nowcasting and longer range probabilistic forecasts are more realistic objectives.
- To benefit from predictable small-scale forcing – downscaling (land/sea, orography, land-use). May still be dominated by large-scale error.
- To represent both small and large-scale effects of deep, moist convection (much) and (some) gravity waves more accurately than convection schemes can achieve. Hence to develop organisation of convection more accurately.
- If we are lucky, a combination of the above!
- + other reasons but above most general.



# CSIP IOP 18 – 25/08/2006

## Model forecast

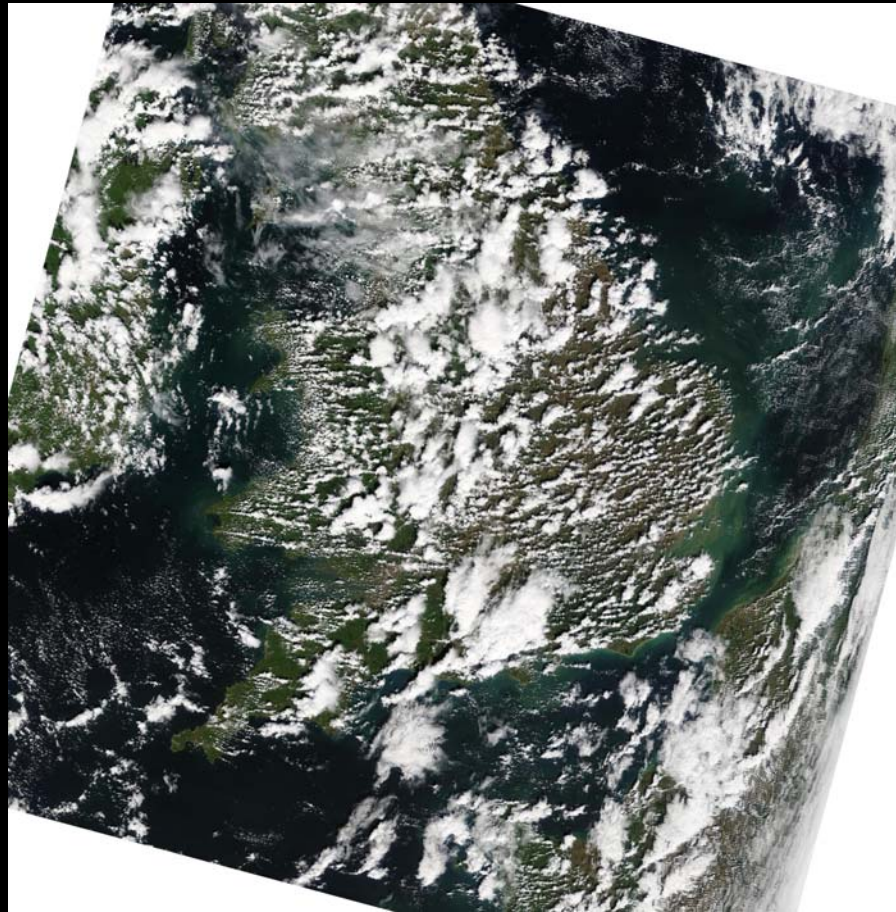

Modis Terra 1125 UTC

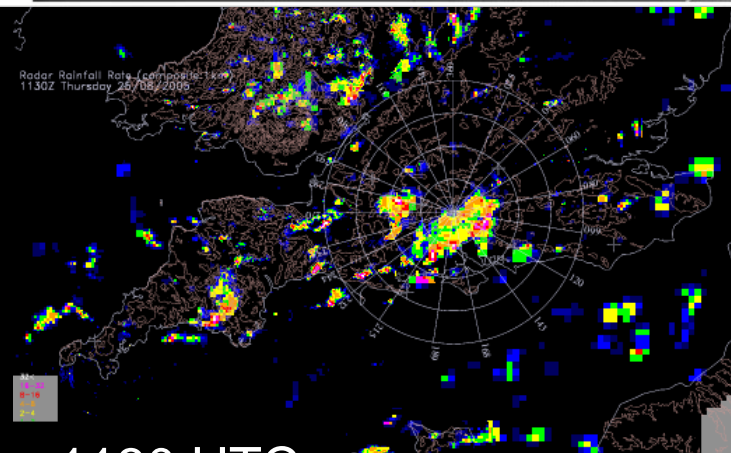
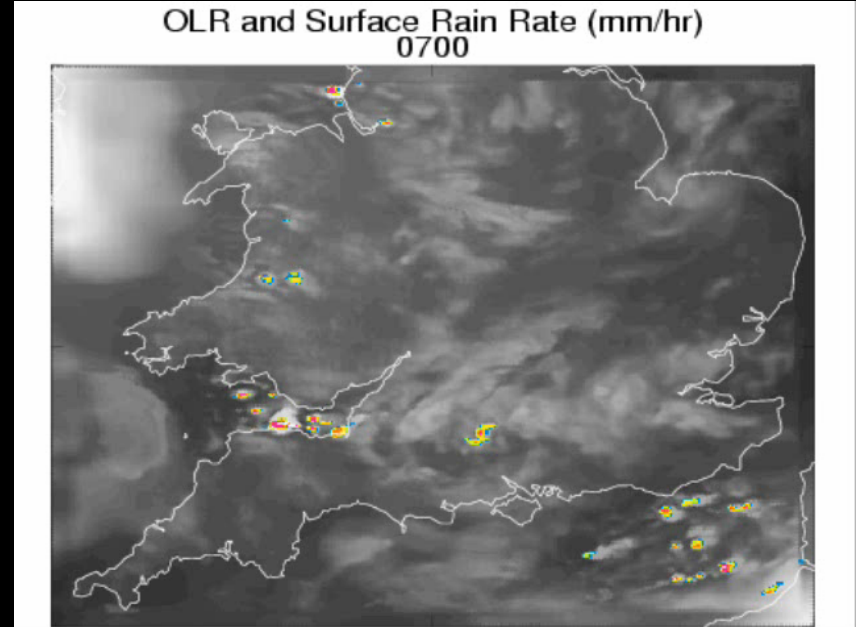

Radar 1130 UTC



# Results from a year of forecasts (2003) from the Met Office mesoscale model (12 km)

95<sup>th</sup> percentile threshold (top 5% of accumulations)  
~ 0.5 mm

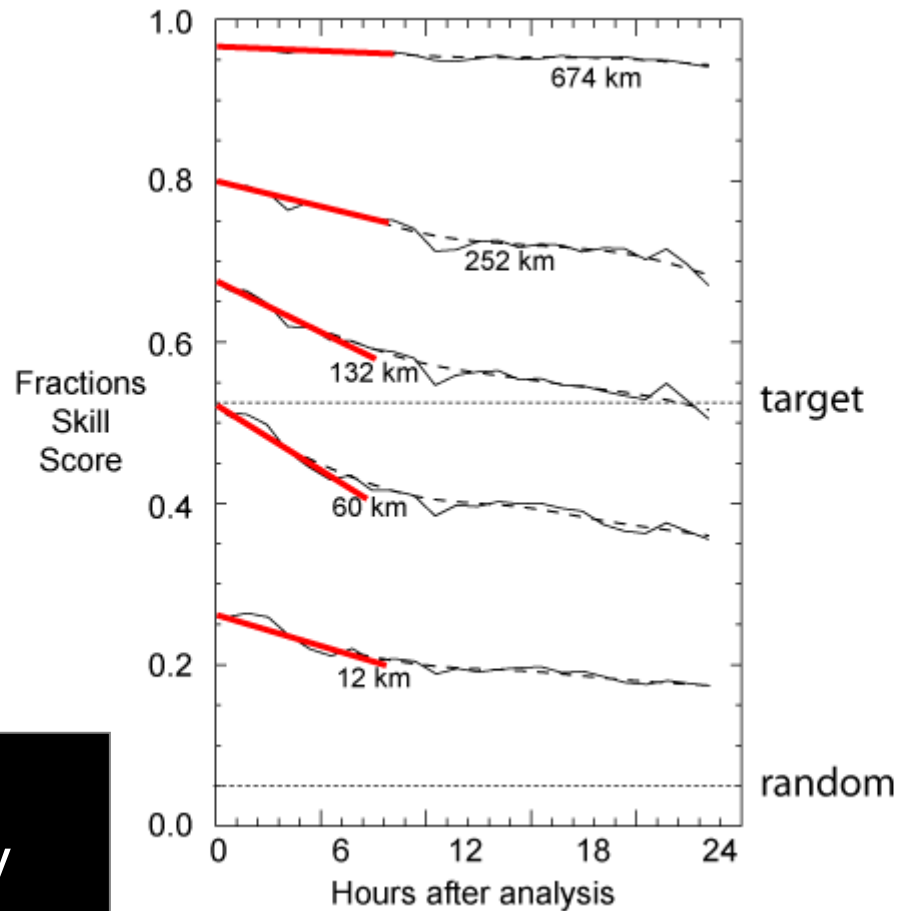

Verification of spatial accuracy of rainfall forecasts

Nigel Roberts, Met. Apps 2008



# Results from a year of forecasts (2003) from the Met Office mesoscale model (12 km)

95<sup>th</sup> percentile threshold (top 5% of accumulations)  
~ 0.5 mm

Verification of spatial accuracy of rainfall forecasts

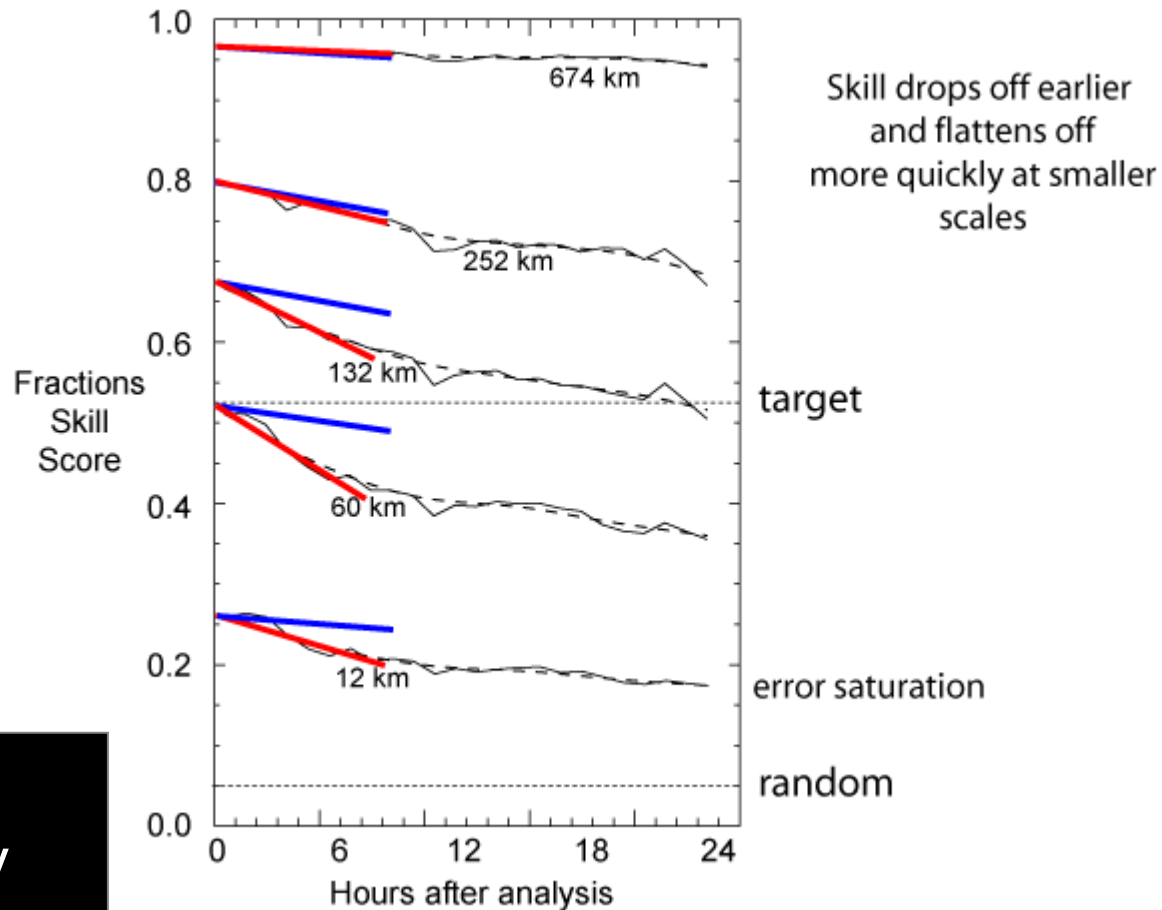

Nigel Roberts, Met. Apps 2008



# Results from a year of forecasts (2003) from the Met Office mesoscale model (12 km)

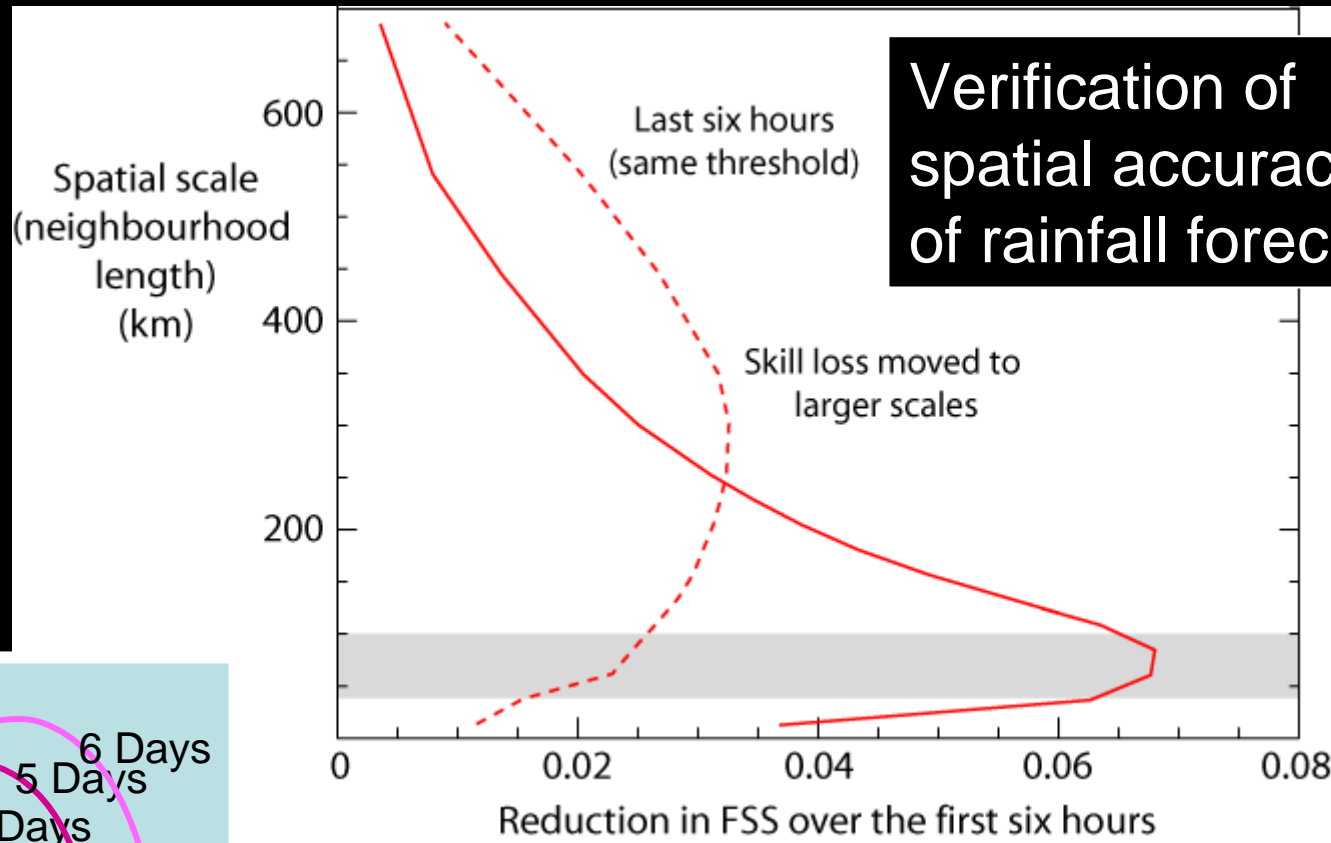

Verification of spatial accuracy of rainfall forecasts

(Lorenz)

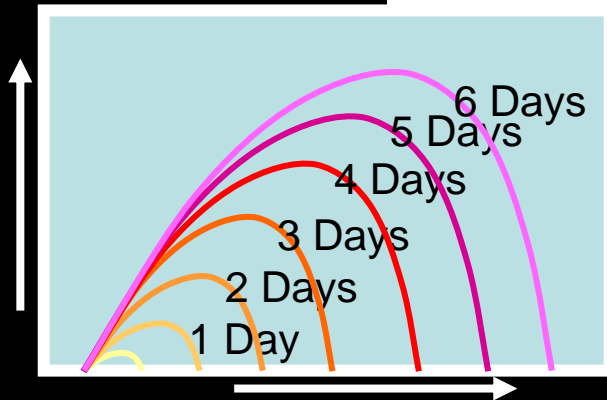

Nigel Roberts, Met. Apps 2008



# Skill vs realism

- Current 12 km model has useful skill at T+24 at scales  $>\sim 140$  km.
- Scales finer than this important primarily for
  - Realistic upscale transport – PV, moisture etc.
  - Realistic correlations – e.g. cloud field in radiation, surface exchange etc.





# 'Convective-scale' has some skill advantage over ~10 km

- It is easy to find examples of qualitative improvement in simulations of convection using 1-2 km vs 10-20 km. (European examples from Meteo-France, DWD).
- It is hard to find quantitative improvements, partly because of scores – however this is appearing at least for short forecasts.

2004 & 2005 summer cases

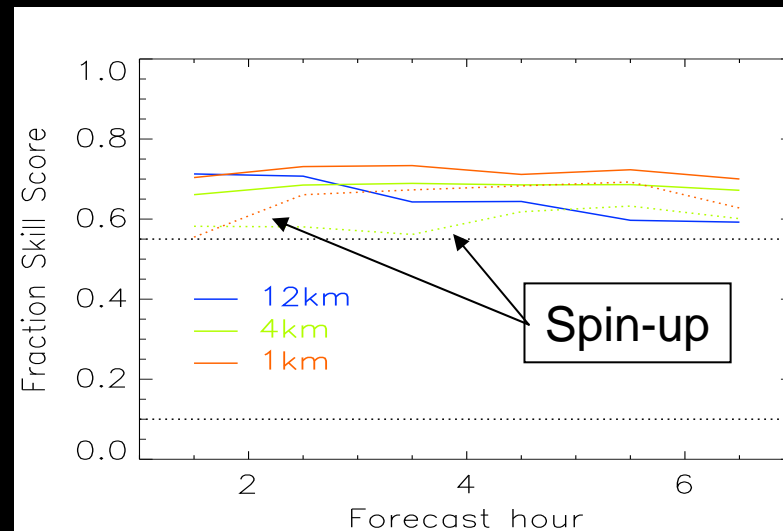

Trial results from convective cases over UK using the UM



# Surface schemes: what additional complexity is needed?

- Surface properties – greater variety, more information, more sophistication?
  - Urban surface exchange a particular emphasis
- Soil moisture – at what point 2 way coupling to a 3D hydrological model essential?
  - Orographic rain feedbacks (e.g. DWD experience).
- Coastal SST, tides etc..
  - Sea breezes, convection, coastal fog and Sc
- Radiation and orography (slopes, shadowing).
  - How '3D' do we need to be.



# Urban Surface Exchange – hierarchy of complexity

Modified 'traditional' surface energy budget  
'Rough, well drained concrete'

How to specify parameters?  
Difficult to get storage so nocturnal H right

'Street Canyon' surface energy budget  
Roughness, albedo, sky view factor functions of geometric parameters

Canopy too heterogeneous for roughness  
Need wind within canopy layer

Explicit Urban Canopy  
Distributed drag, heat and moisture exchange



# Urban surface exchange in the UM

- The UM uses a 'tile' surface exchange scheme, including an 'urban' tile.
- The urban tile is quite crude:
  - Enhanced roughness.
  - Enhanced drainage.
  - Modified albedo.
  - Urban 'thermal canopy' to represent thermal inertia of buildings.
  - Anthropogenic heat source
- Much improved scheme under test.

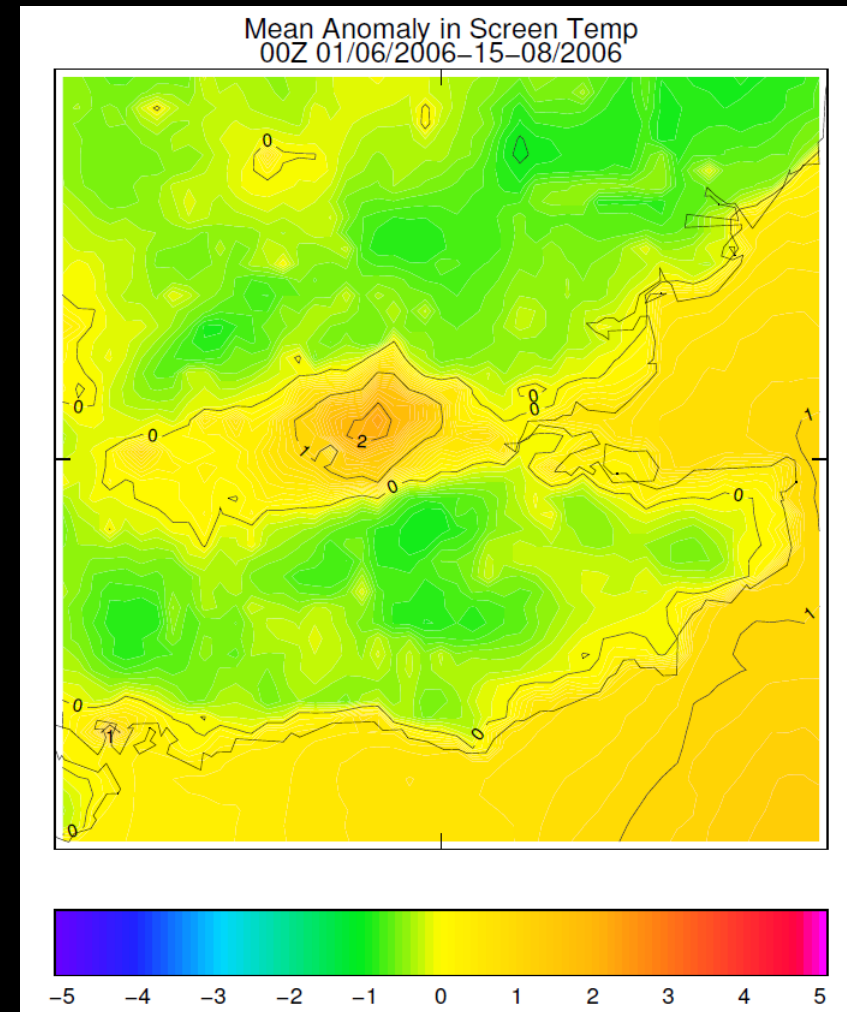

Nocturnal heat island in 4 km forecast—  
01/06-15/08/2006 00 UTC

# 'Urban canyon' urban schemes.

- Effective surface roughness.
- Geometric albedo  $f_n(\text{solar angle})$ , sky view factor.
- Multi-facet scalar exchange. Each facet has different thermal inertia.
- Masson (2000) TEB model exemplar.

## Scalar transfers to atmosphere

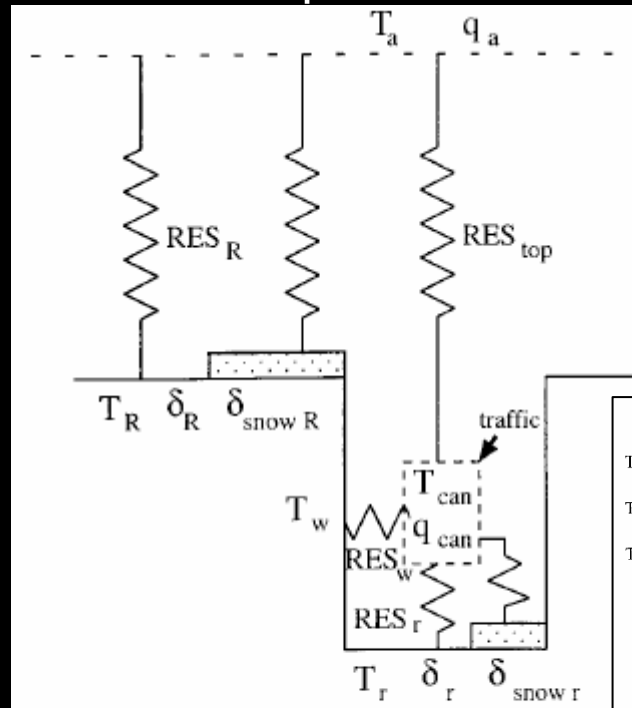

## Radiation

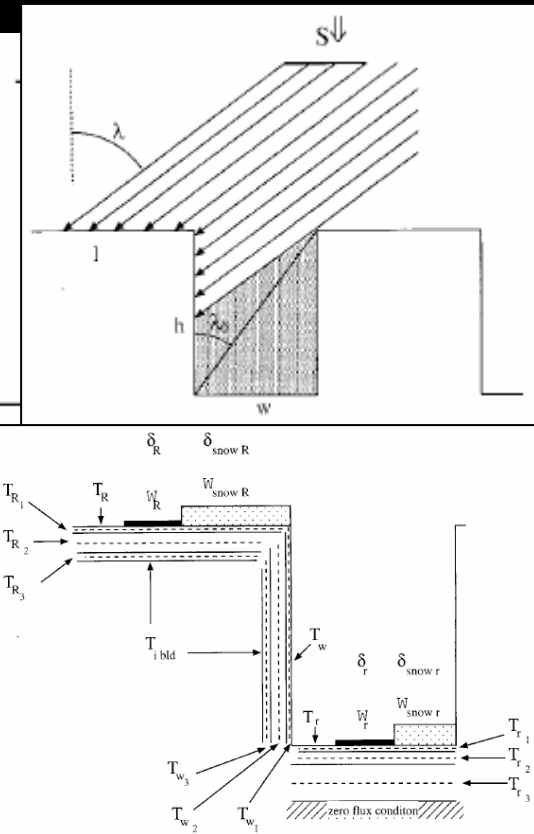

a) Aerodynamical resistances

Figure 3. Scheme options for: (a) aerodynamic resistances; canyon.

Heat transfer in building surface

Masson, BLM 2000

# Urban Canyons and the new UM 2 tile urban scheme

- Negligible roof <-> canyon coupling.
- Single canyon temperature.
- Implies two-tile simplification.

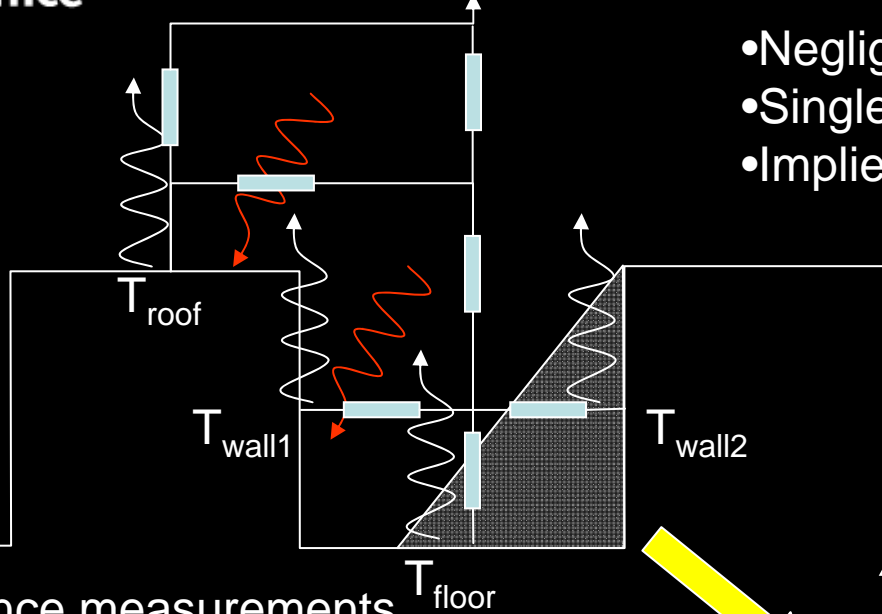

- Resistance measurements (Barlow/Harman)
- Resistance model (Harman)
- Radiation model and two surface simplification (Harman)
- Two-tile surface only (Best) UM
- Two-tile with radiation model single column UM (Harman)
- Full UM implementation (Porson)

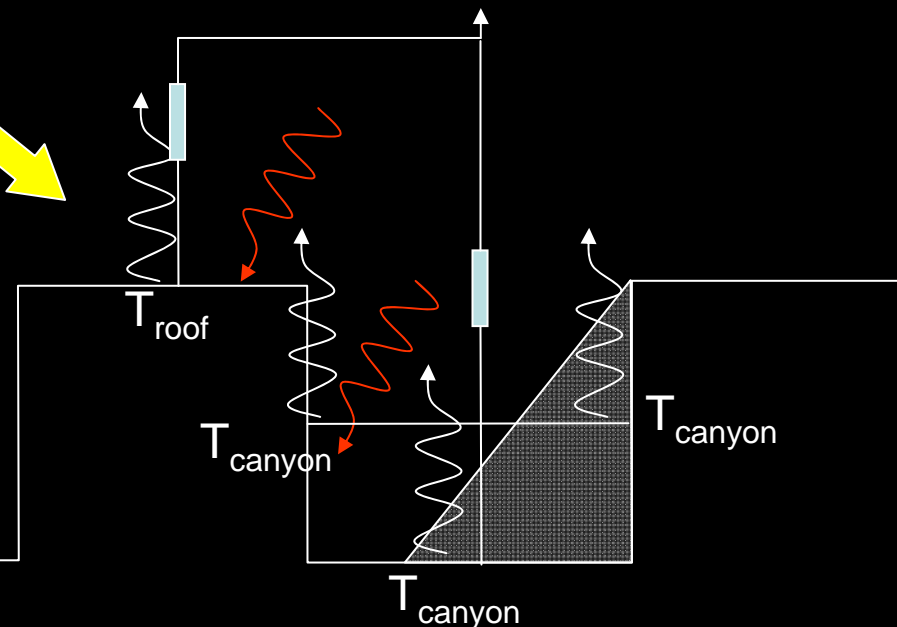
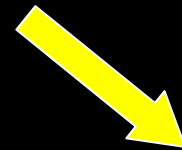



# Surface-only tests of 2 tile scheme

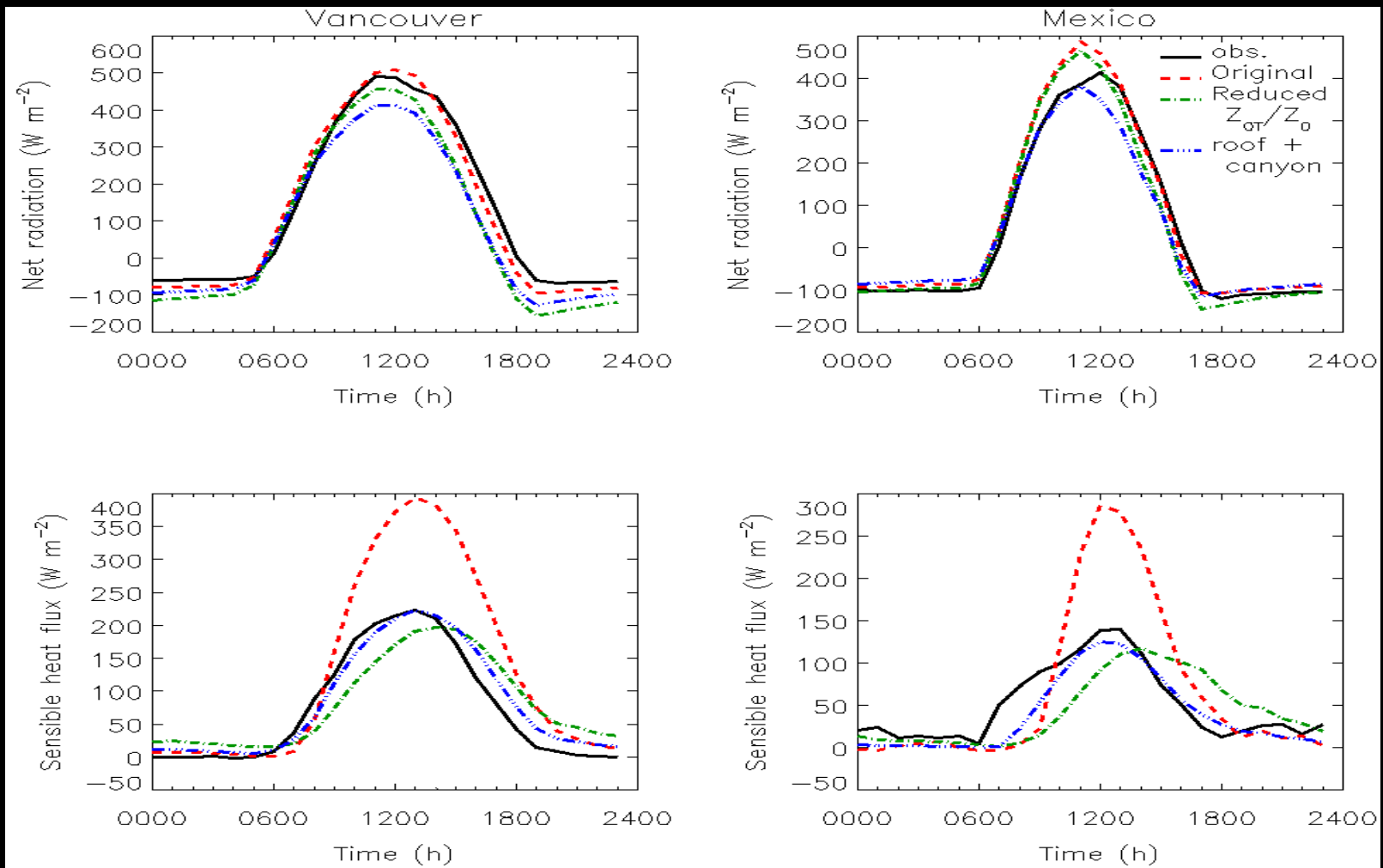

# 'Urban Canopy' urban schemes.

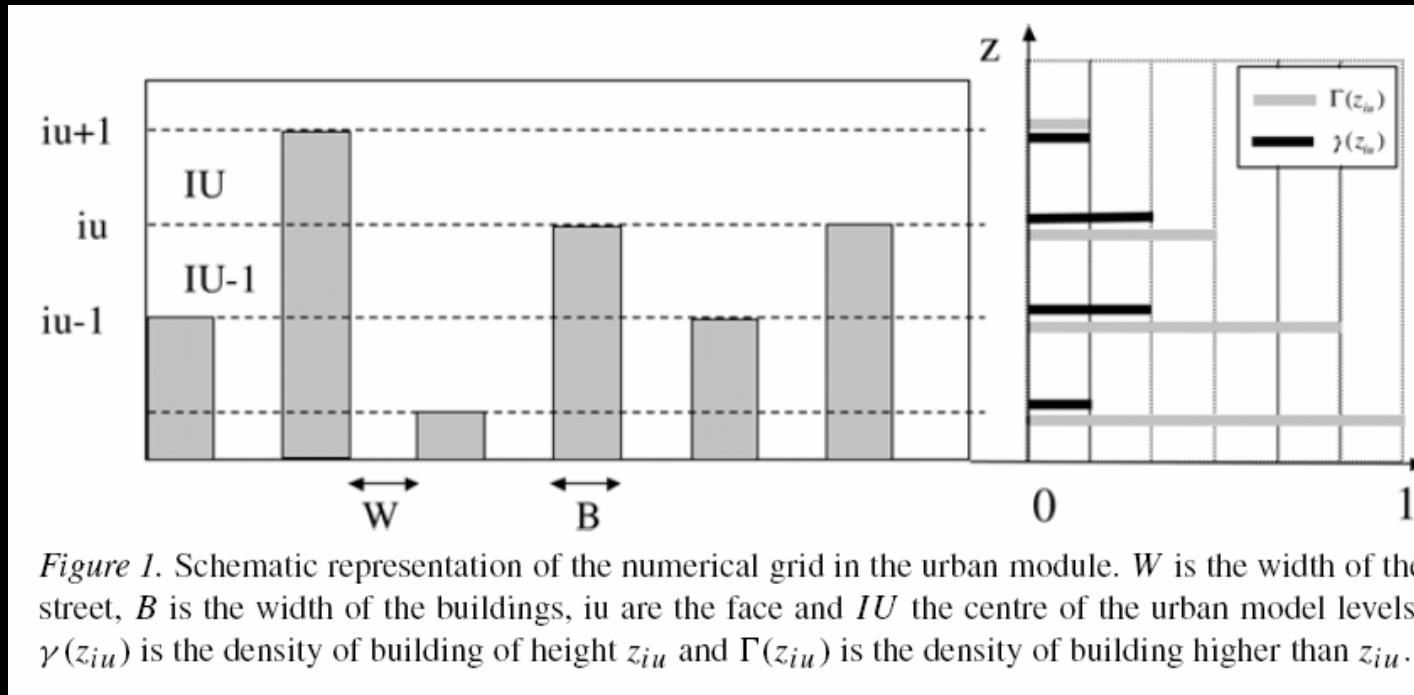

Martilli, BLM, 2002

- No longer a 'surface' scheme – distributed.
- Very data-hungry.
- Martilli exemplar.





# Urban Schemes – concluding remarks

- There are very many schemes in existence differing in complexity – exemplars typify classes of scheme. Considerable progress in recent years.
- Availability and standardisation of urban parameters is a major issue. Schemes sometimes developed to suit available data rather than *vice versa*.
- A model intercomparison project is currently underway under Sue Grimmond (KCL)
  - <http://geography.kcl.ac.uk/micromet/ModelComparison/index.htm>
  - Emphasis on performance with ‘standard’ parameters as much as on ‘perfection’.
- Urban moisture is still a very difficult problem.

# Orography and Radiation

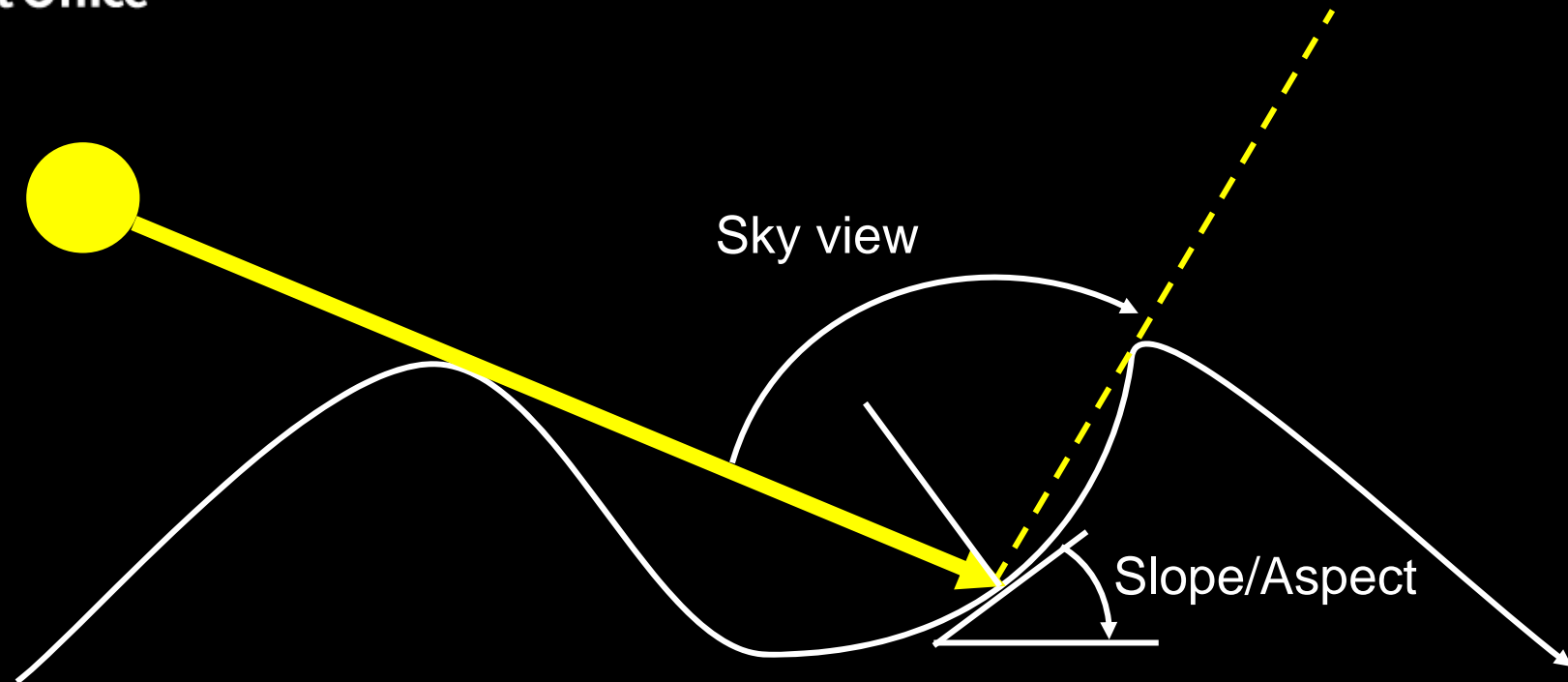

- Most large-scale models have 1D radiation schemes and treat the surface as flat.
- Variation in surface slope increases as resolution increases.

# Orography and Radiation

- Short wave:
  - Direct (S) (Slope, aspect, shadowing)
  - Diffuse (D) – anisotropic (Slope, aspect, ‘sky view’ factor)
  - Reflected (R)
- Long wave
  - Atmosphere (A) – sky view
  - Terrain (T) – sky view, spatial variability of surface.

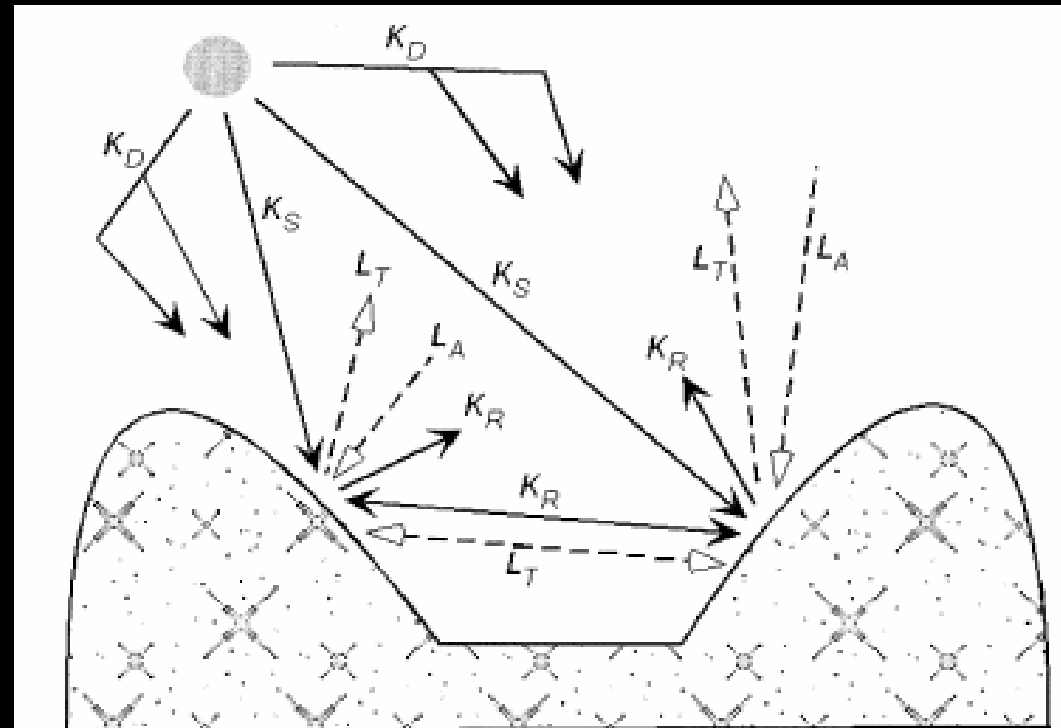

FIG. 1. Schematic representation of short- and longwave components of surface radiation fluxes in complex topography (adapted from Barry 1992).

Oliphant *et al*, JAS, 2003



# Orography and Radiation

- Oliphant *et al* (2003) found decreasing order of importance slope aspect, slope angle, elevation, albedo, shading, sky view factor, leaf area index. (Southern Alps, NZ).
- Slope aspect/angle have direct impact throughout day from SW direct beam.
- Shading, sky view factor have impact on SW at dawn/dusk when SW small anyway.
- Relatively easy 'retrofit' – (UM now has slope/aspect)
- Möller and Scherer showed 0.5-1 C RMS improvement in 2 m T from explicit sub-grid model, but this may be extreme.

| Model                | Considered topographic influence on radiation |
|----------------------|---|
| ARPS                 | Slope, aspect, shadow                         |
| Bolam <sup>a</sup>   | None  |
| HIRLAM <sup>b</sup>  | None  |
| LM/aLMo <sup>c</sup> | None  |
| MASS <sup>d</sup>    | Slope, aspect                                 |
| MC2b <sup>e</sup>    | None  |
| Meso ETA             | None  |
| Meso-NH              | Slope, aspect                                 |
| MM5 <sup>f</sup>     | Slope, aspect                                 |
| NMM                  | None  |
| RAMS <sup>g</sup>    | Slope, aspect                                 |
| RUC <sup>h</sup>     | None  |
| U.K. Unified Model   | None  |
| WRF <sup>i</sup>     | None  |

Möller and Scherer, MWR, 2005

UM now includes slope/aspect



# Spatial impact of model changes.

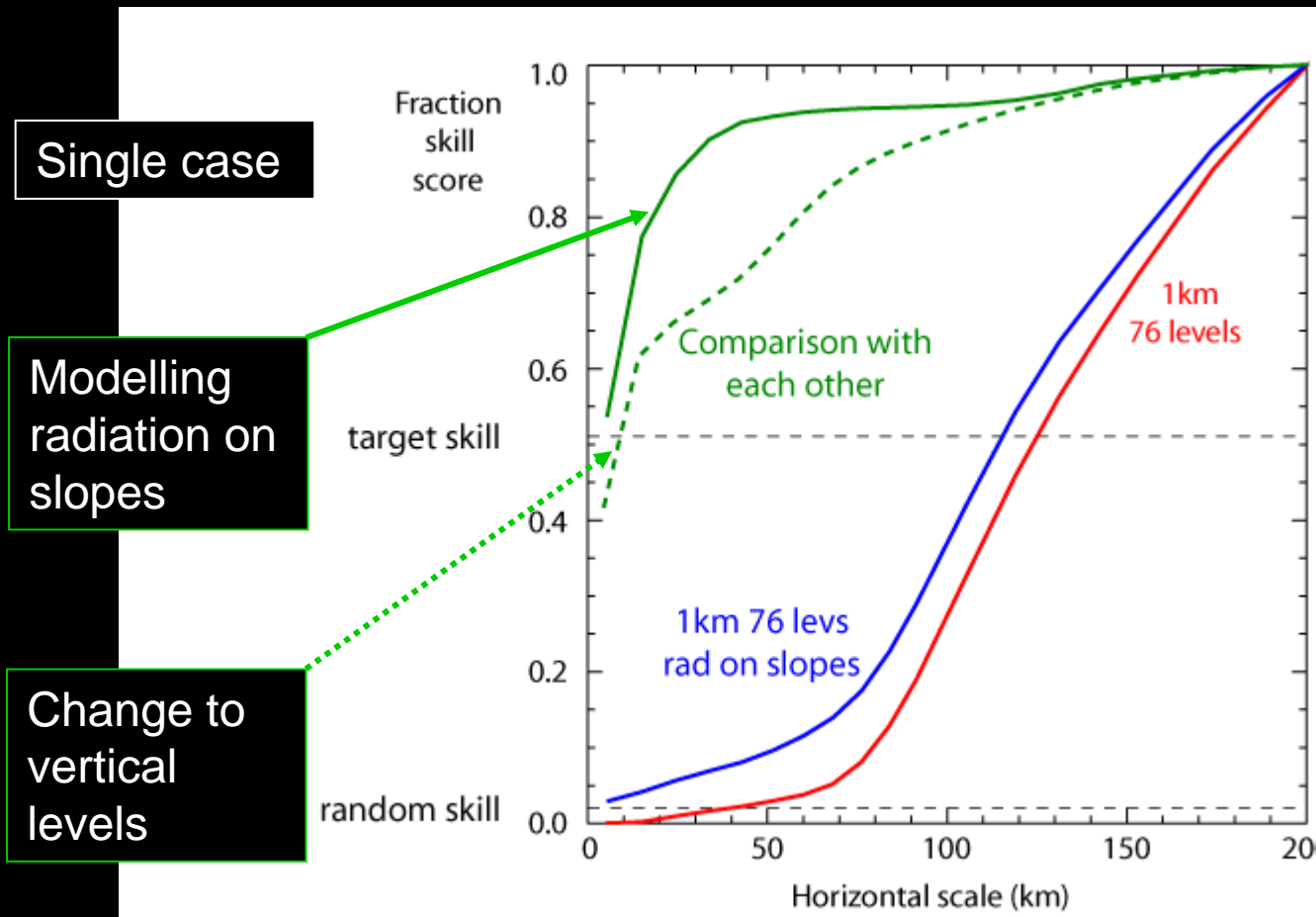

- Impact of slope is inevitably more close to grid scale.
- May not have large impact on model skill.

Roberts, 2007, MWR



# 3D Radiation?

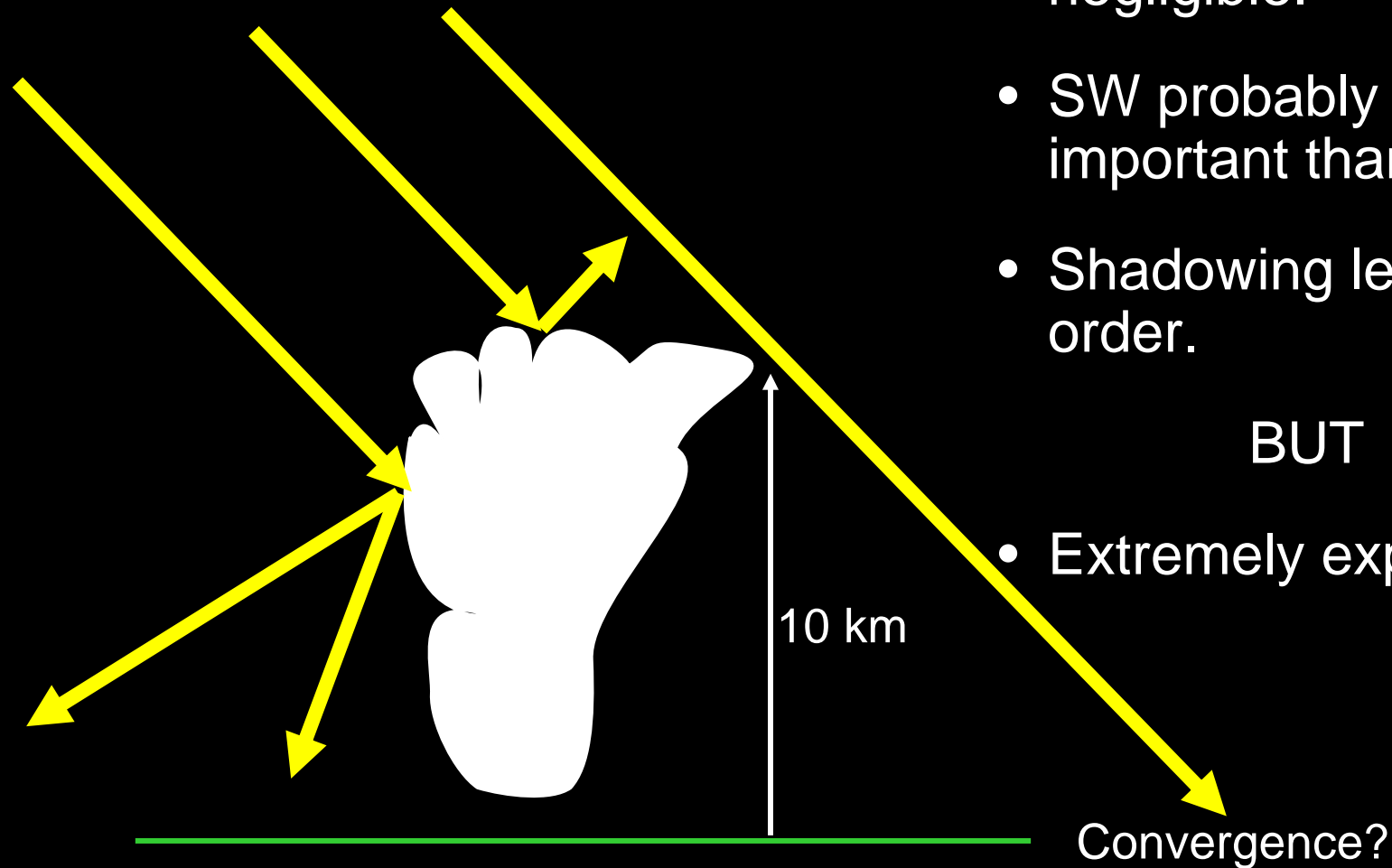

- 3D effects are not negligible.
  - SW probably more important than long.
  - Shadowing leading order.
- BUT
- Extremely expensive!



# 3D Radiation

- In principle convective-scale models need 3D radiation.
- In practice, we get away without. Why?
  - Individual clouds poorly forecast anyway – we need to look for systematic errors.
  - Clouds usually move and timescale for atmospheric response to shadowing  $\sim$  timescale for BL overturning  $\sim h/w^* \sim 20 \text{ min} \sim 10 \text{ km}$ . Acts as low pass filter.
  - Only organised response will produce systematic error, e.g. cloud streets.
  - 3D scheme needs good 3D cloud properties.
  - (See Marsham, Q.J. 2008, for nice study of impact cirrus shadowing on convection triggering).



# Cloud Microphysics

- 'Bin' schemes too expensive for operational forecasting.
- So-called 'bulk' schemes use  $n$  'species' each with specified form of size spectra (typically gamma or exponential).
- Each spectrum characterized by  $m$  parameters, usually expressed as moments. Volume/Mass/Mixing ratio (3<sup>rd</sup> moment) is a natural choice, followed by number concentration (0<sup>th</sup> moment).
- Natural split between cloud liquid water, rain water and various ice species.
- How many species are needed? How many moments?





# Do we need a prognostic species?

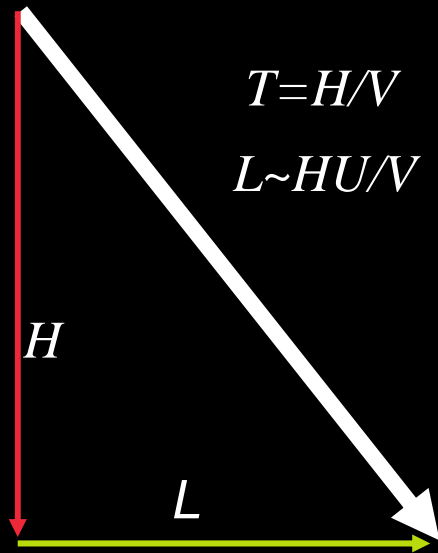

$$\frac{\partial Q_x}{\partial t} + \nabla \cdot [(\mathbf{u} - V\mathbf{k}) Q_x] = S_x$$

$$\rho \frac{D(Q_x/\rho)}{Dt} - \frac{\partial}{\partial z} (VQ_x) = S_x$$

$$\rho \frac{D_H(Q_x/\rho)}{Dt} + \frac{\partial}{\partial z} [(w - V) Q_x] - \frac{Q_x}{\rho} \frac{\partial}{\partial z} (\rho w) = S_x$$

Horizontal advection can be ignored if  $L \ll dx$

|         |              |
|---------|--------------|
| Cloud   | L very large |
| Rain    | L ~ 5 km     |
| Snow    | L ~ 50 km    |
| Graupel | L ~ 1-2 km   |

# Convective-scale cloud microphysics

- 6 phase schemes with vapour, cloud water, rain water, ice, snow, graupel fairly typical.
  - E.g. WRF (Purdue/Lin, WSM6), UM, Meso-NH.
- Though many schemes can be traced back to earlier schemes (e.g. Rutledge and Hobbs 1983, 1984), a very wide variety of expressions for inter-conversion terms exist, often designed for specific regions/climates/types.

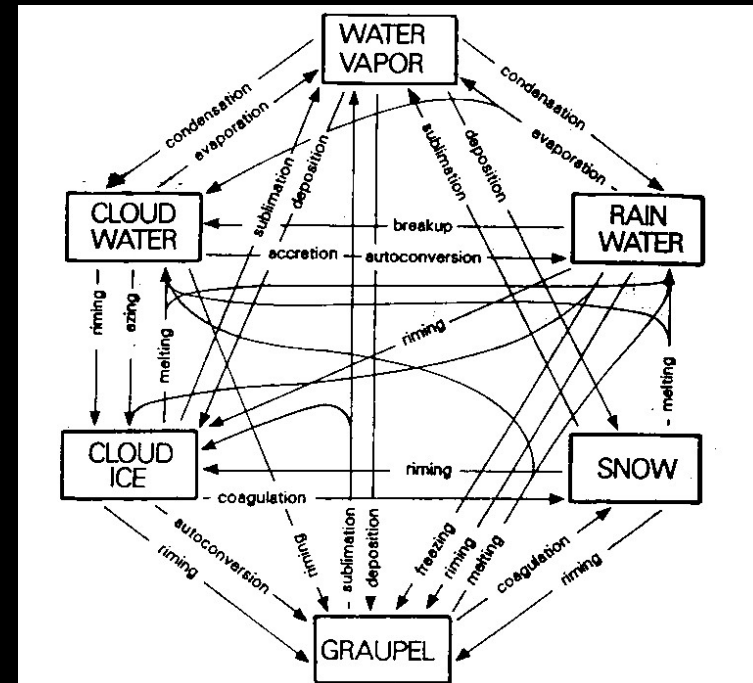



# The need for higher order microphysics schemes

- Bulk schemes in terms of mass are good for representing inter-conversion by collection processes iff particle number conserved, e.g. accretion of cloud by rain. (Note Rutledge and Hobbs 1983 studying seeder/feeder).
- Other processes conserve (or approx. conserve) mass but change number – self-collection/autoconversion.
- Warm rain is a very good example. Stochastic coalescence conserves cloud water ( $q_c$ ) but gradually broadens size spectrum until sufficient large drops available to generate rain.  $N_c$  decreases with time with same  $q_c \rightarrow$  larger drops. Similar considerations apply to ice  $\rightarrow$  snow autoconversion.
- Two moment schemes are not uncommon e.g. Cohard and Pinty (2000) warm rain scheme in Meso-NH.
- Graupel has further complications of ‘wet growth’ modes – depends on dissipation of latent heat of freezing so area or density an important parameter. Triple moment schemes sometimes used in research models.



# Main uncertainties in cloud microphysics

- Ice/snow fall speeds, growth and collection depend on particle shape (habit) – a given set of parameters is likely to work well for a given type of cloud and temperature regime.
- Ice nucleation represents a constant problem:
  - Homogeneous rates?
  - Heterogeneous – assumptions re ice nuclei
  - Ice multiplication (Hallett-Mossop process).
- Coupling to aerosol schemes is a research question – sensitivity easy to show but need more work using ‘climatological’ aerosol to demonstrate systematic impact.



# Microphysics/dynamics coupling in convection

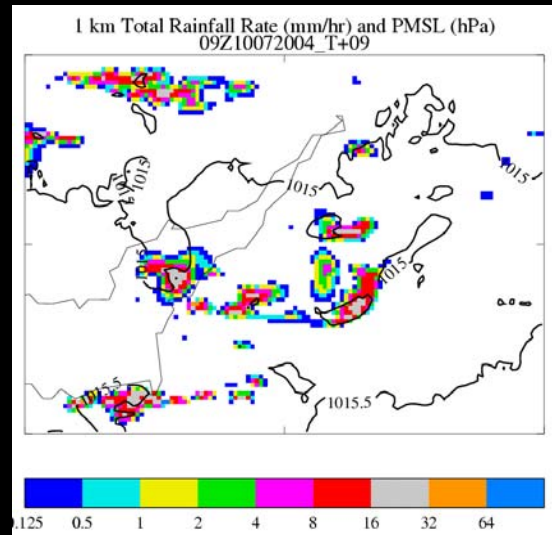
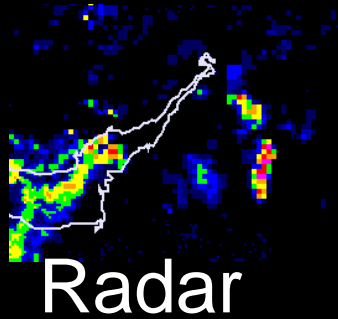

10th July 2004 1 km UM 0900 Z

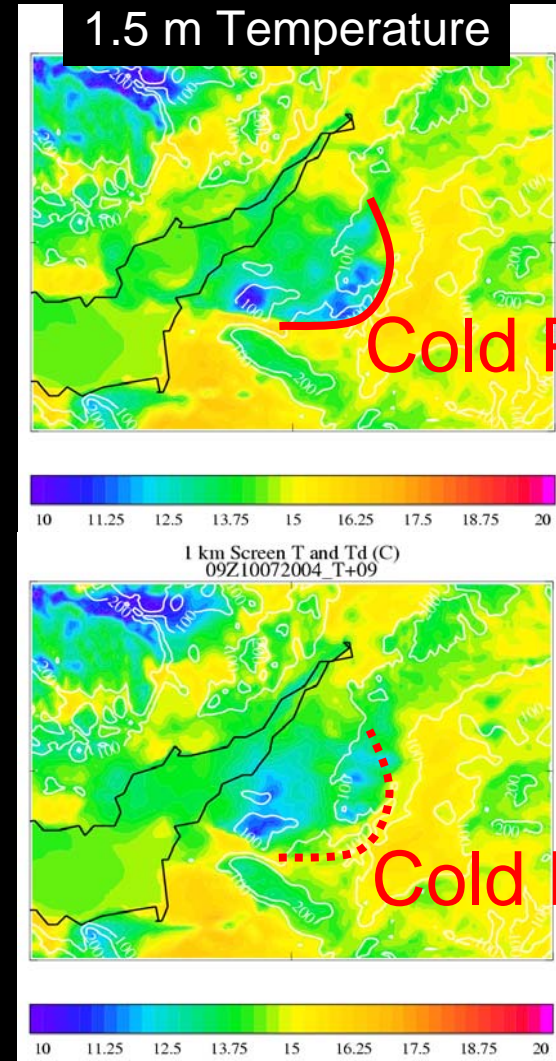

Different shaped snowflakes



# GCSS Case 4 (LBA)



LBA: Amazon River Basin

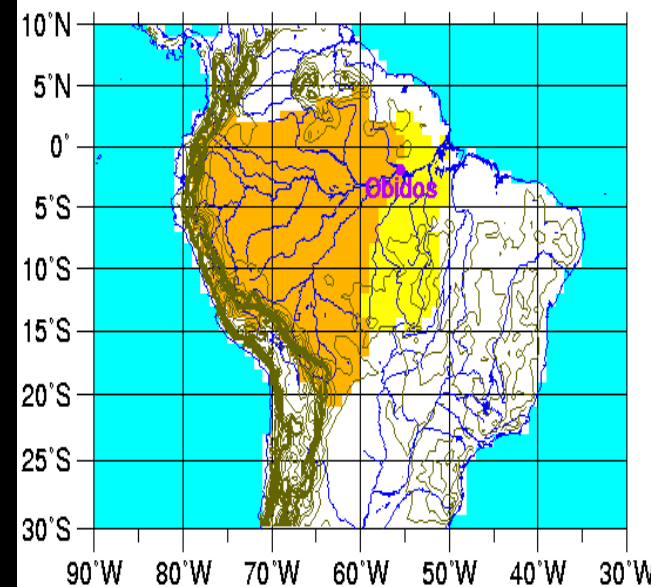



# GCSS TRMM-LBA Diurnal Cycle

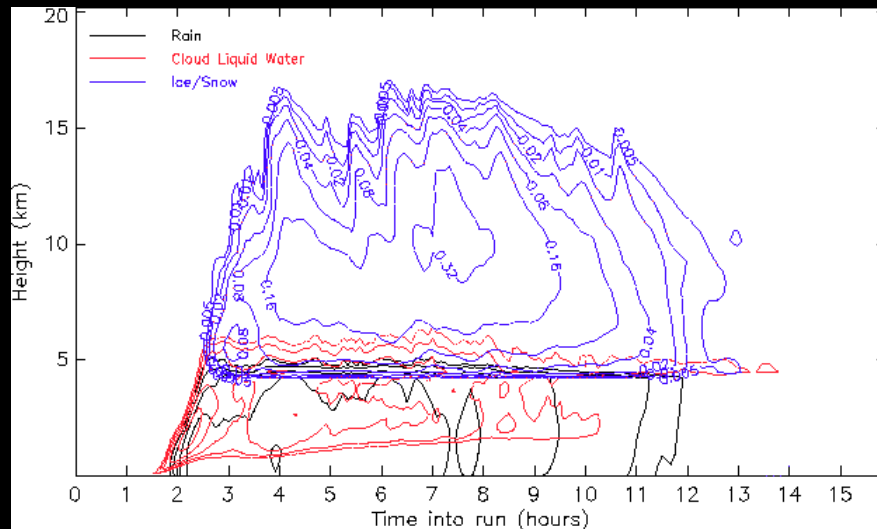

UM Reference

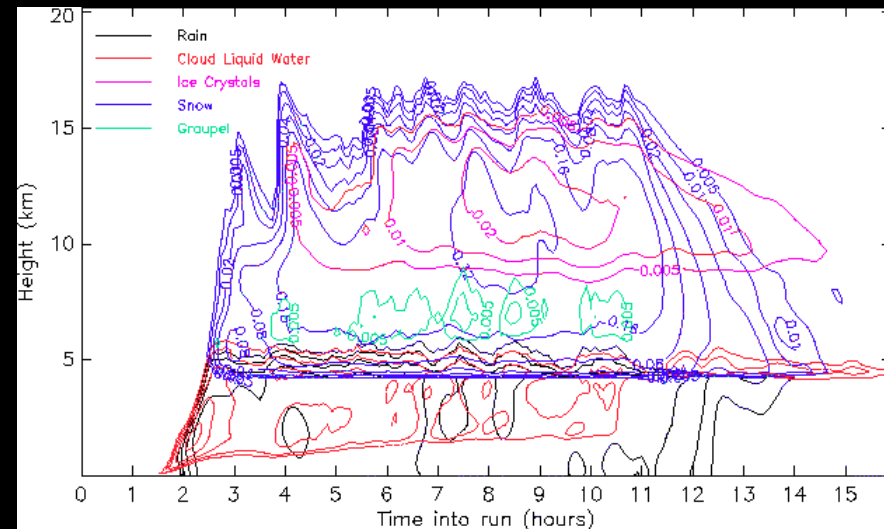

UM with enhanced  
microphysics

(Richard Forbes)



# Turbulence, Boundary Layer and Convection: RANS vs LES

- Reynolds average = ensemble average  $\sim$  volume average iff averaging length  $\gg$  largest eddies (spectral gap). So RANS supposed to contain ALL turbulence and produces 'steady' flow at turbulence scales.
- LES = volume average with averaging length  $\ll$  largest eddies. Usual closure assumes homogeneous with averaging length in inertial subrange.
- Typified by turbulence scheme of Cuxart et al, Q.J.R.Met.S. 2000 – TKE-based scheme suitable for RANS BL (mixing length  $\sim$  characteristic outer length-scale for turbulence) and LES (mixing length  $\sim$  grid scale).
- Deep convection permitting = LES BUT inertial subrange (probably)  $\sim$  100 m (Bryan et al, MWR 2003) NOT  $\sim$  1 km.





# Prandtl's mixing length paradigm

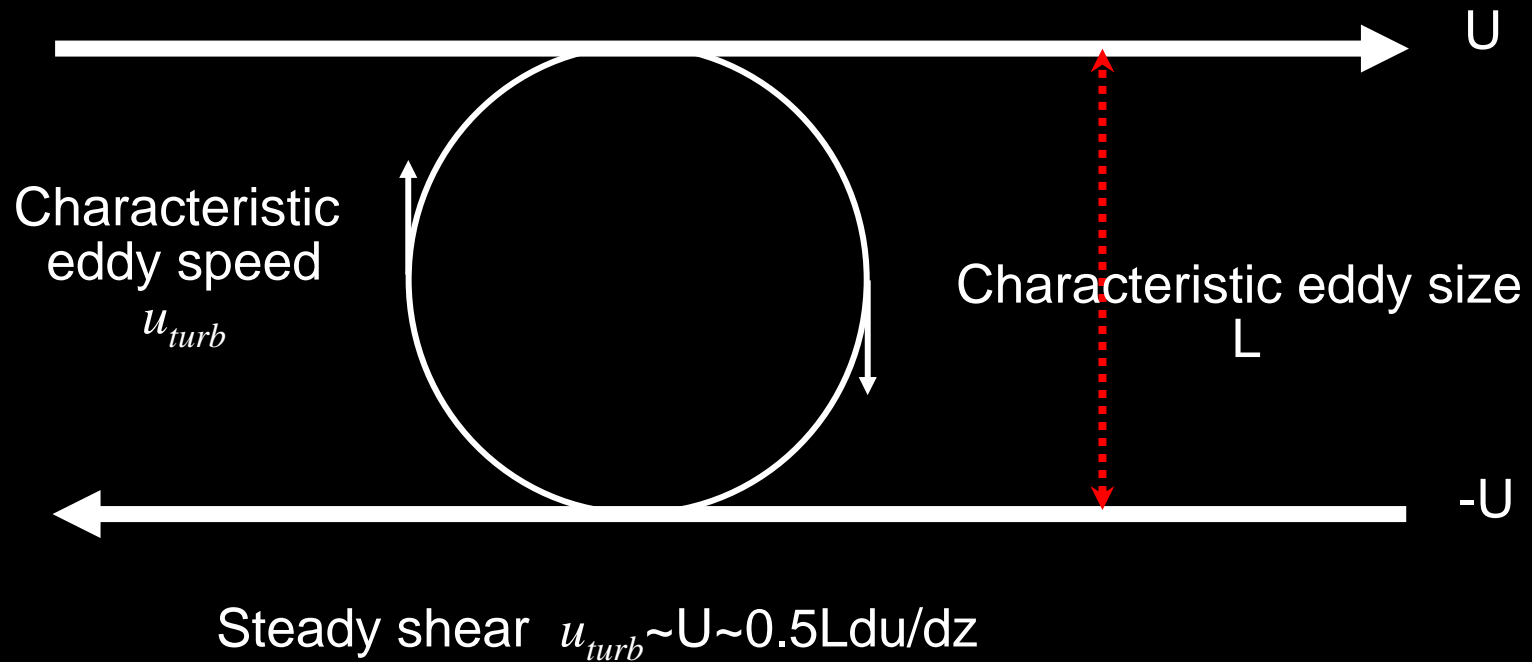



# Turbulence, Boundary Layer and Convection: RANS vs LES

Many (most ) local schemes have form:

$$\langle u'_i y' \rangle \sim u_{turb} y_{turb} \sim u_{turb} \left( L \frac{\partial \langle y \rangle}{\partial x_i} \right)$$

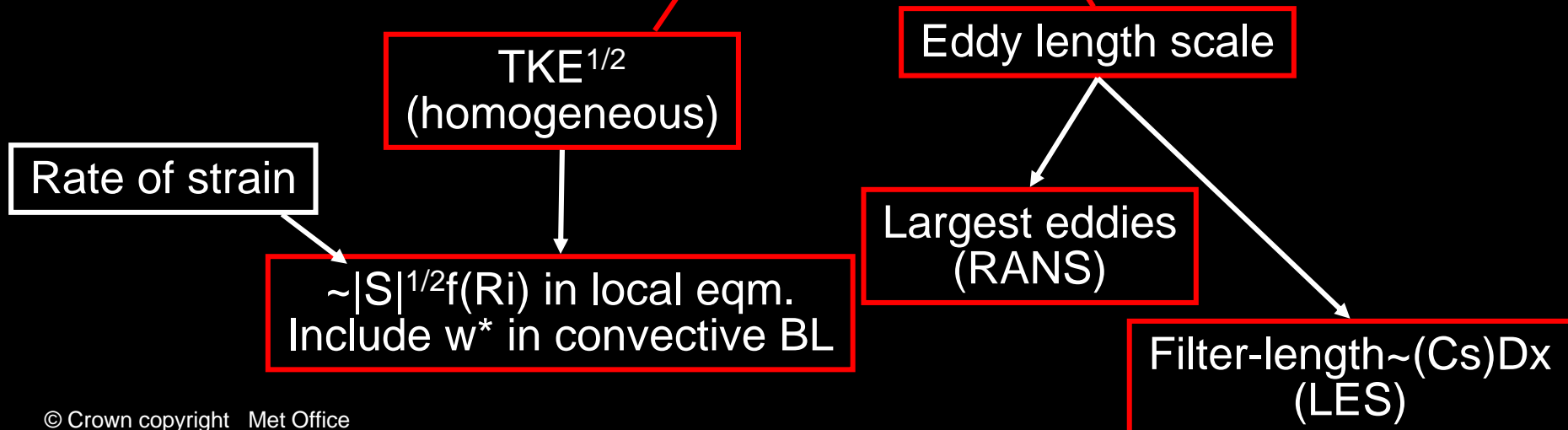



# Approaches to turbulence and mixing: Vertical

- Vertical very similar to larger scale
  - Local, non-local, higher-order local in BL.
  - Non-local schemes especially in convective BL (CBL) – bulk diagnosis of BL depth, surface and entrainment fluxes, counter gradient terms.
  - Higher order local schemes emphasise vertical transport of turbulence e.g. from middle CBL into stable entrainment layer.
  - Local schemes (or nothing!) outside BL.
  - Local higher order schemes can more easily be extended to sub-grid condensation (via  $\langle w'^2 \rangle$  or more complex).
  - Local higher order schemes may be more numerically smooth than 1<sup>st</sup> order schemes (see Wood, 2008 analyses of non-linear diffusion)



# Approaches to turbulence and mixing: Horizontal

- ~1-2 km resolution, 'true' resolution is ~5-10(+) km (Skamarok, MWR, 2004 ). This is (much) larger than largest energy containing eddies in the convective boundary layer.
- In general,  $D_x \gg D_z$  (even outside PBL)  $\Rightarrow d^2/dx^2 \ll d^2/dz^2$ .
- In principle, no change required to BL.
- Even outside BL, horizontal mixing is usually relatively small-scale compared with a few horizontal gridlengths, so horizontal 'diffusion' slow.
- In principle, 'do nothing' for horizontal mixing, 'business as usual' for vertical is a valid starting point.

BUT



# Approaches to turbulence and mixing: Horizontal

- Practical problems do occur.
  - ‘Do nothing’ isn’t really a meaningful option, as ‘nothing’ does something!
  - Stable dynamical core dissipates at grid scale – behaves roughly as high viscosity fluid; solutions may develop which may or may not resemble true atmosphere but with wrong scales. E.g. convective cells, BL roll vortices.
  - Nature of deep convective cells very dependent on horizontal mixing. Not clear what to do with vertical.
  - Shallow convection is a new ‘grey zone’. In principle, we definitely need to parametrize shallow convection as **most** of the motion is unresolved BUT how do we handle transition from shallow to deep?



# Approaches to turbulence and mixing: Horizontal

- Involves interaction with near-gridscale dynamics so **very** dependent on model. Often depends on history of model!
  - Fixed diffusion (or hyper-diffusion).
  - ‘Horizontal Smagorinsky’ with or without stability corrections, with or without vertical components of shear.
  - ‘3D turbulence closure’.
  - ‘LES’ 3D Filter (Smagorinsky-Lilly)
- 1-2 km **NOT** a very good resolution for deep convection.
  - Clouds very energetic at these scales.
- We should not expect faithful or converged solutions – we are looking for solutions which retain some characteristics of true solution and may have to accept some systematic errors.



# Mesoscale model KE spectra

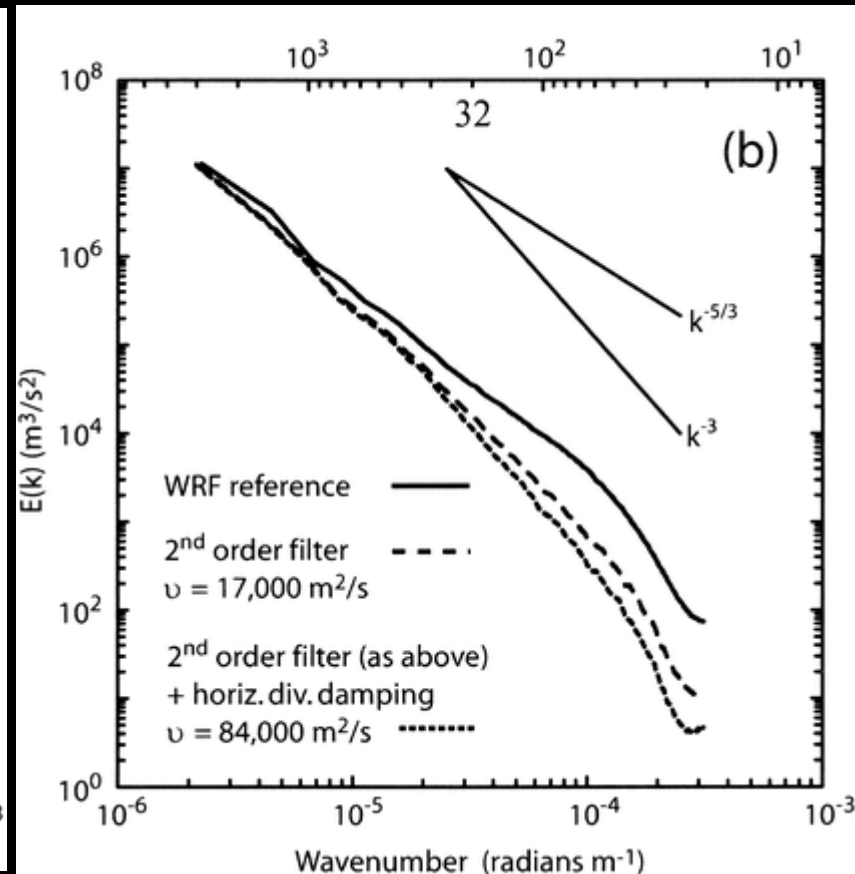
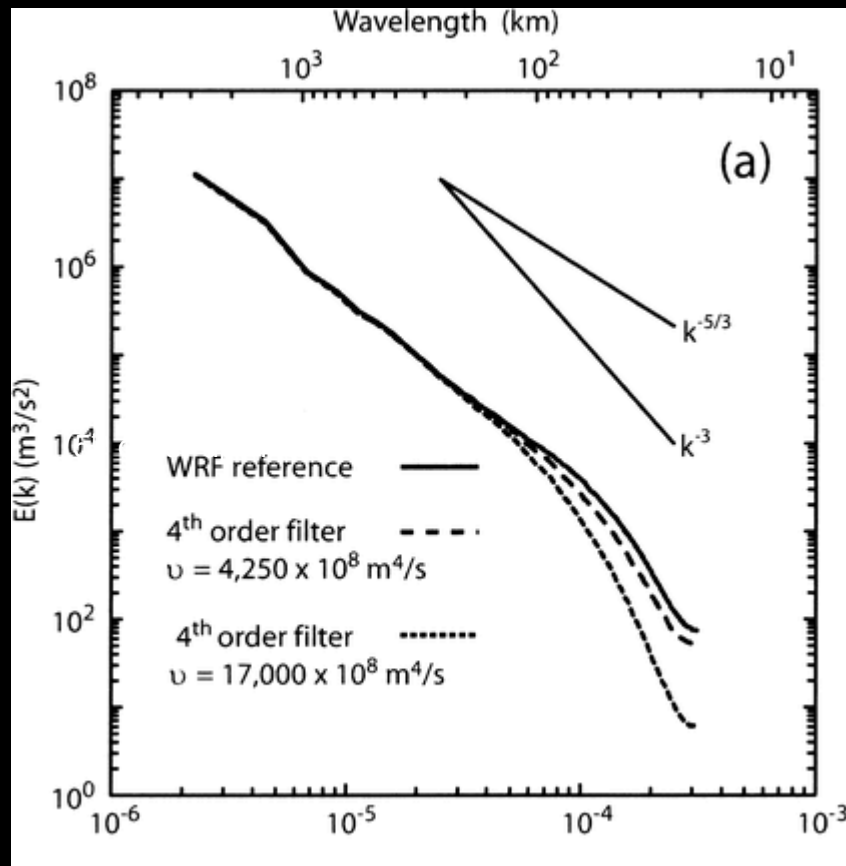

Skamarock, 2004, M.W.R. 132, 3019-3032



# Velocity spectra in scattered convection Limited Area Model

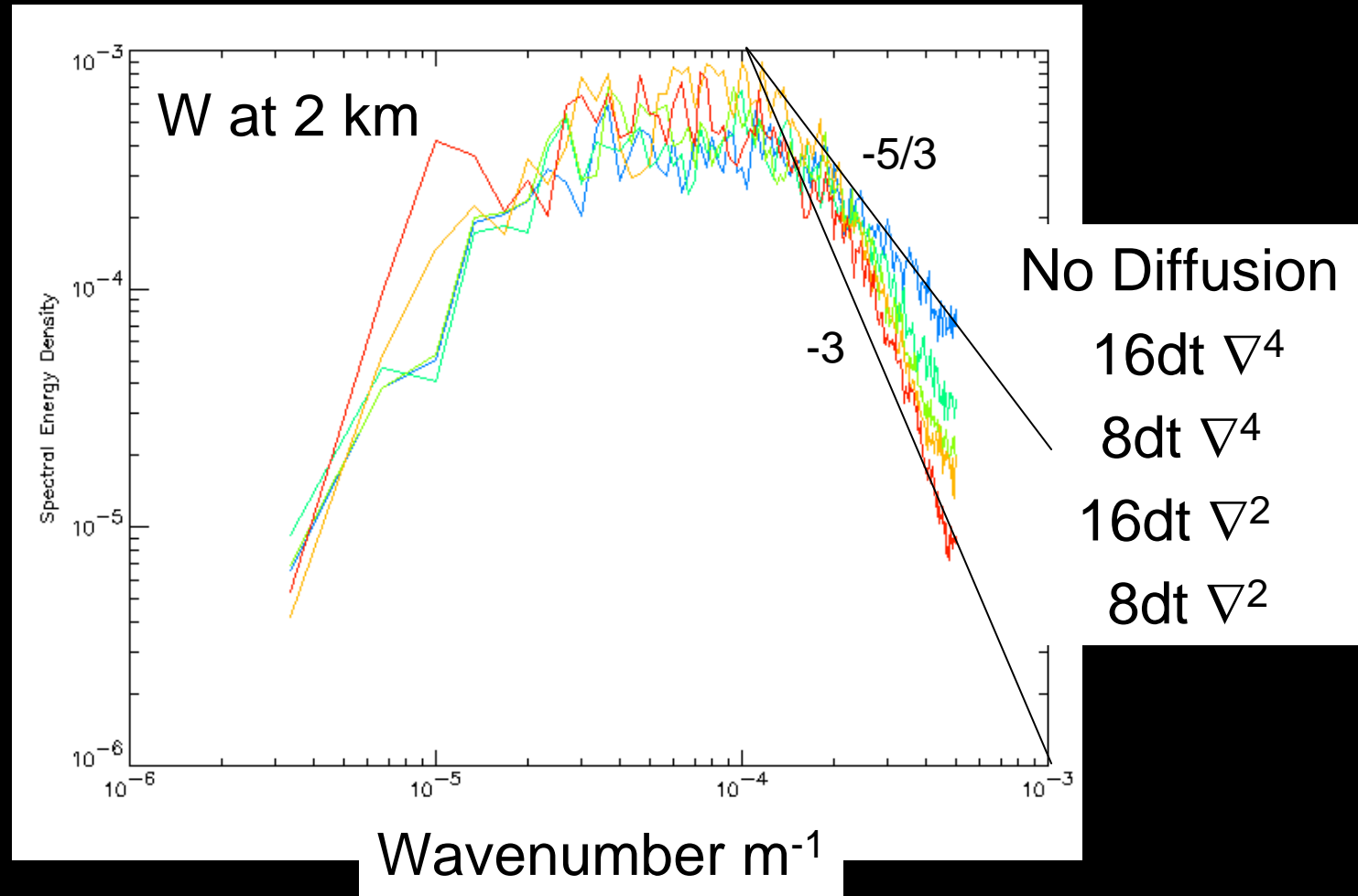





# UM GCSS LBA Idealised diurnal cycle

Biperiodic domain

Fixed horizontal  $\nabla^4$  diffusion

Diurnally forced  
'uniform' showers

Carol Halliwell

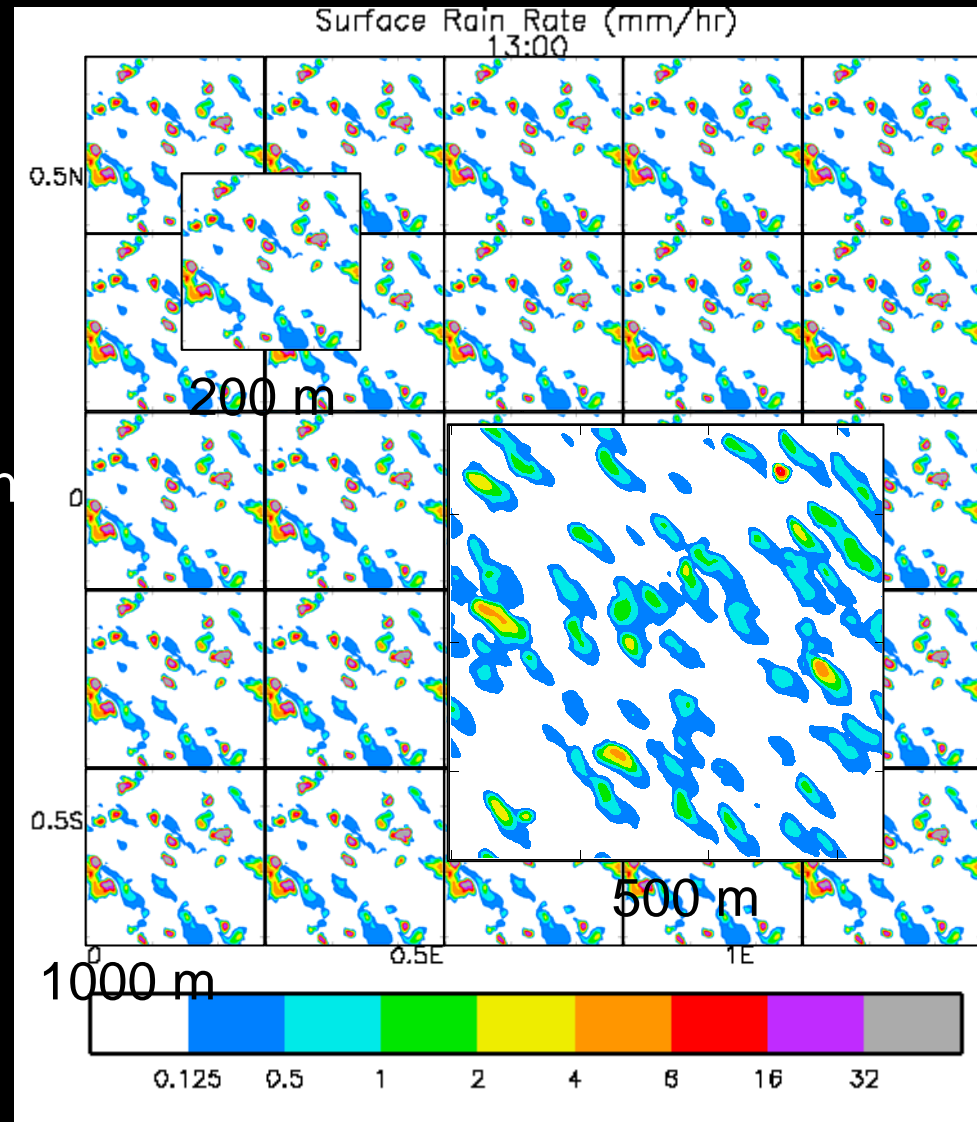



# Impact of fixed horizontal diffusion

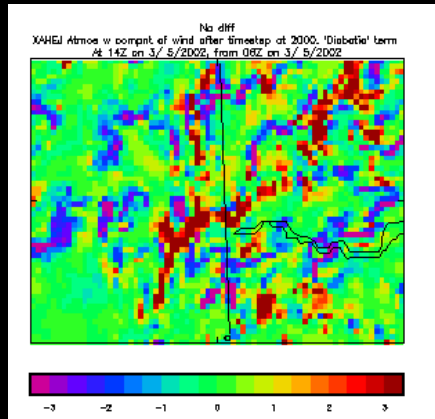

No Diffusion

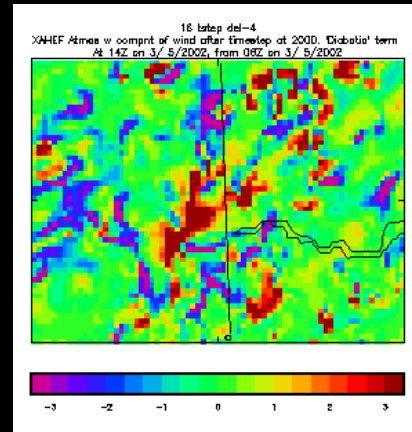

16dt  $\nabla^4$

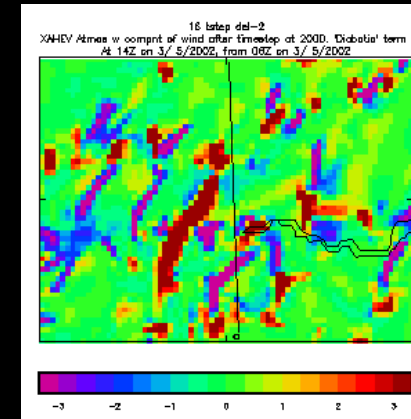

16dt  $\nabla^2$

Timescale=  
E-folding time for  
2dx waves

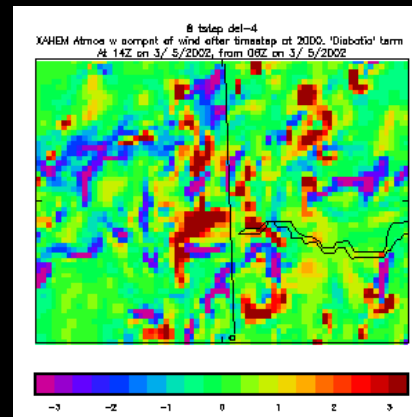

8dt  $\nabla^4$

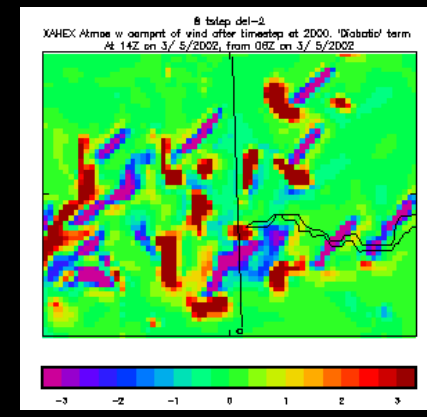

8dt  $\nabla^2$

W at 2 km



# Diurnal Convection: Sensitivity to grid resolution

- Standard 1D BL+horiz. diffusion:  
Increasing delay of first rain and overshoot with decreasing resolution
- “3D” Smagorinsky-Lilly scheme reduces overshoot significantly and reduces variation of delay with res.
- 200m “3D” Smagorinsky-Lilly scheme is close to 200m CRM (within uncertainty)

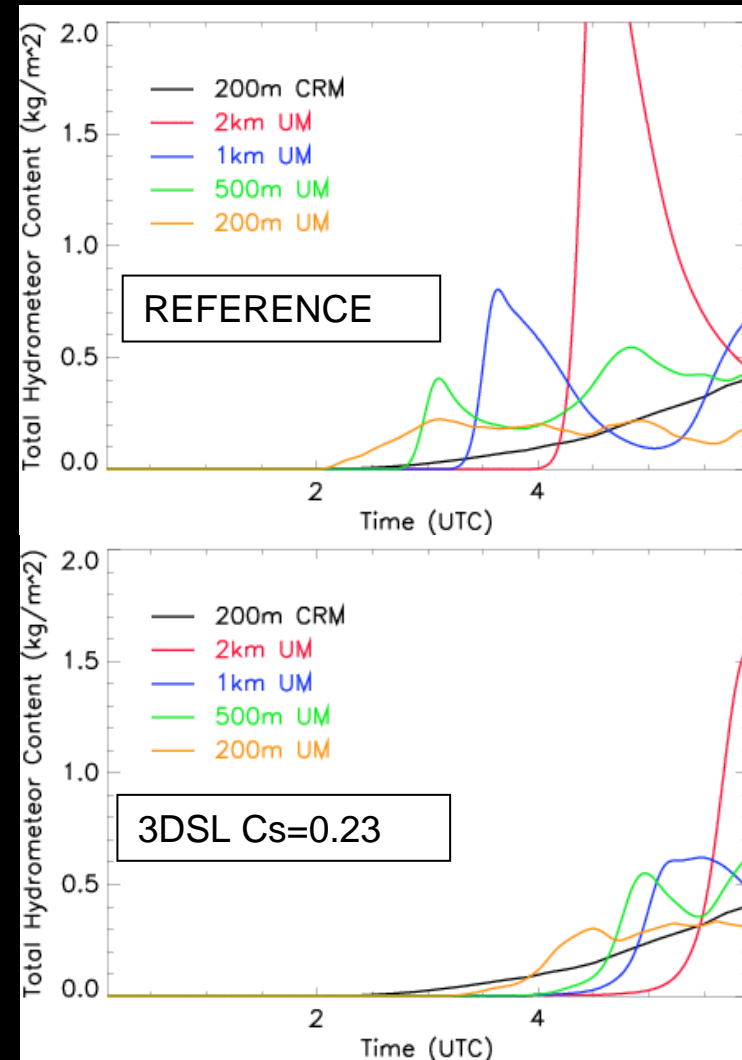
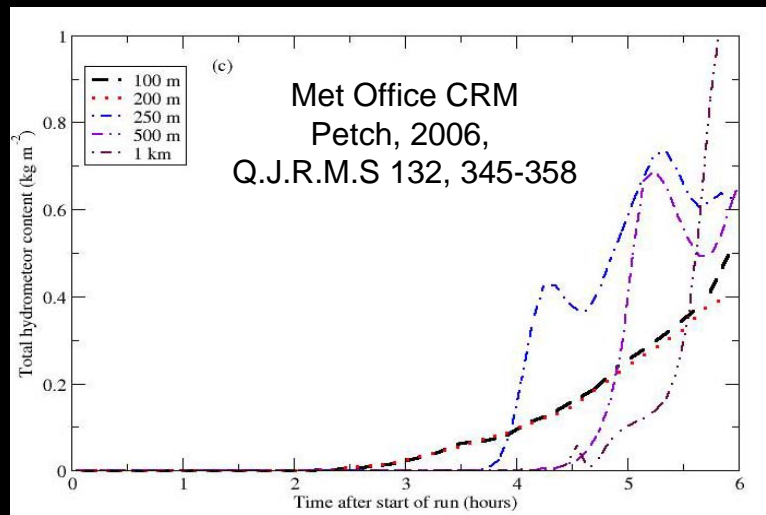

# Met Office CRM (2D)

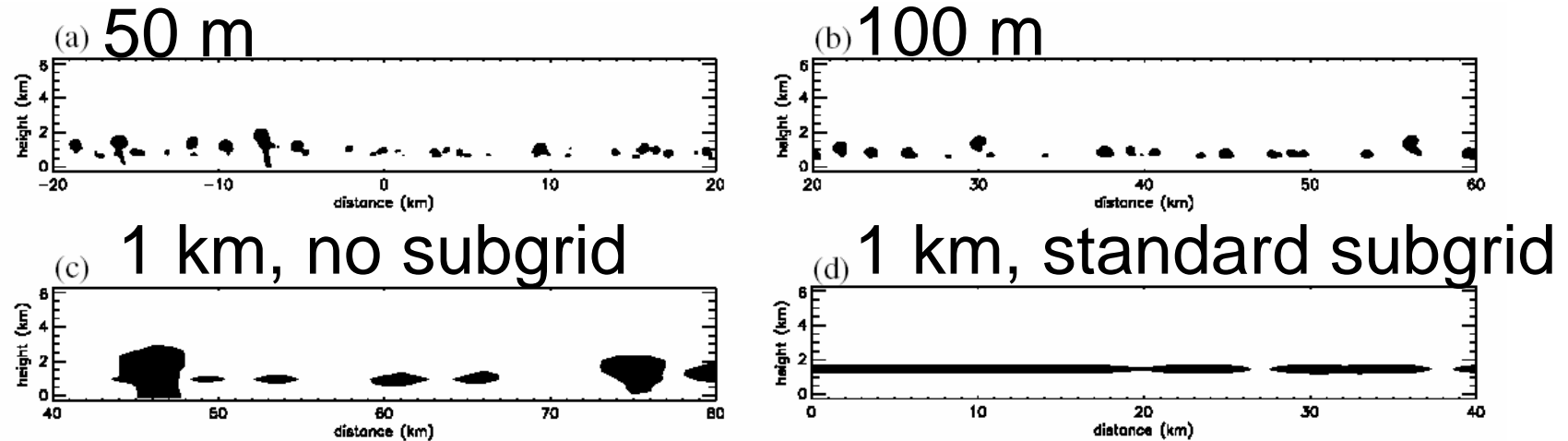

Figure 5. Shaded areas represent regions with a total hydrometeor mixing ratio greater than  $0.05 \text{ g kg}^{-1}$  at a time shortly after the first clouds have formed. Each run is focused on a 40 km region which is typical of the full domain. Results from 2D runs using a grid length of (a) 50 m, (b) 100 m, (c) 1 km and no subgrid mixing, and (d) 1 km and standard subgrid mixing.

Petch, 2006, Q.J.R.M.S 132, 345-358



# Impact of turbulence scheme on convective forecast (CSIP IOP18 - 25<sup>th</sup> Aug 2005)

Reference

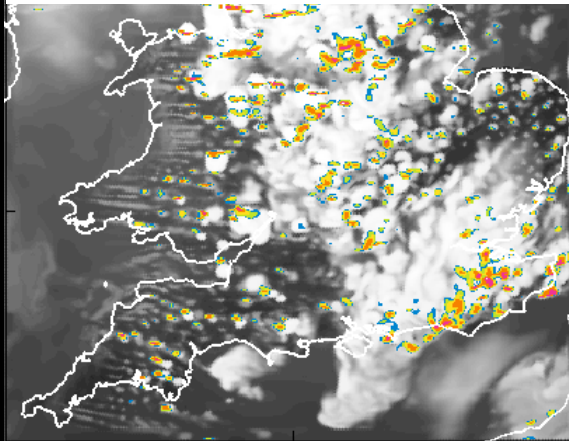

Satellite IR and Radar

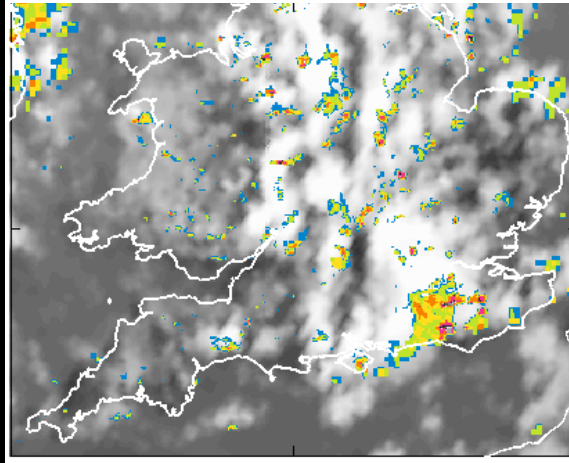

Satellite (Visible) MODIS

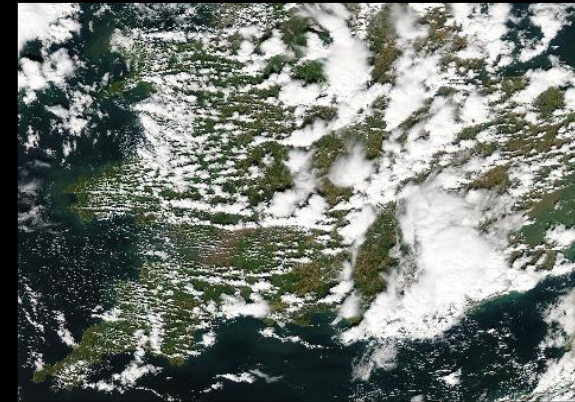

DLR and Surface Rain Rate (mm/hr)  
1300

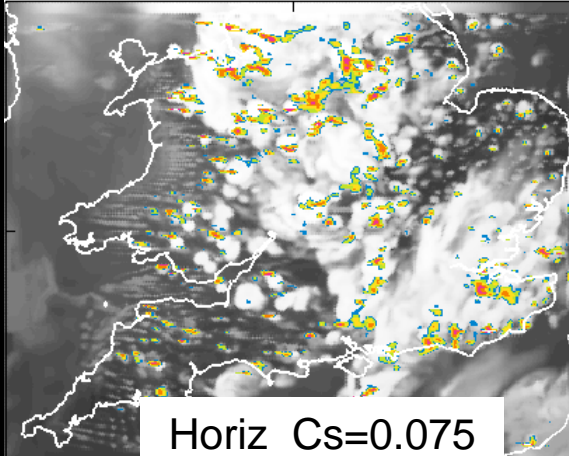

Horiz Cs=0.075

DLR and Surface Rain Rate (mm/hr)  
1300

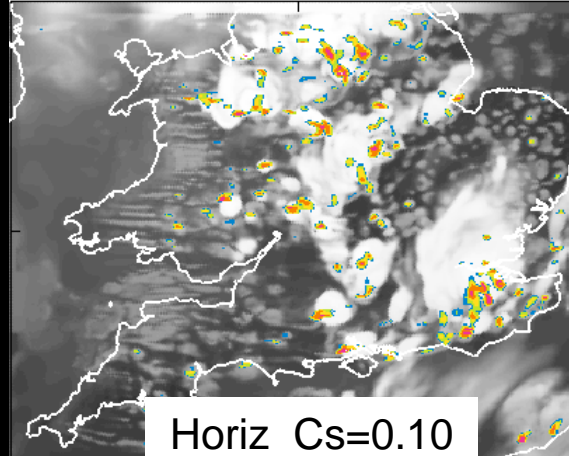

Horiz Cs=0.10

DLR and Surface Rain Rate (mm/hr)  
1300

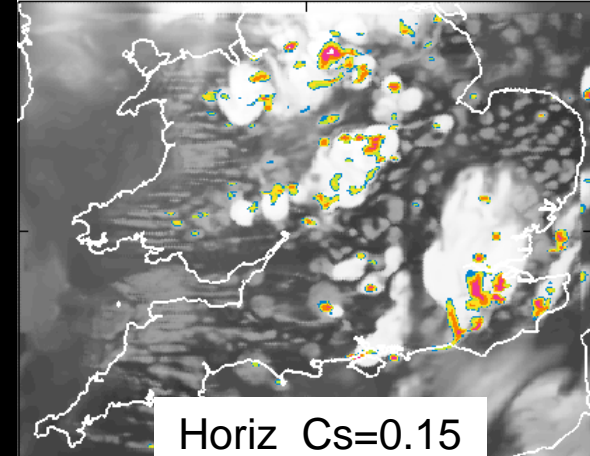

Horiz Cs=0.15



# Convective cell statistics (CSIP IOP18): Sensitivity to turbulence scheme

Average convective cell size as a function of rainrate threshold

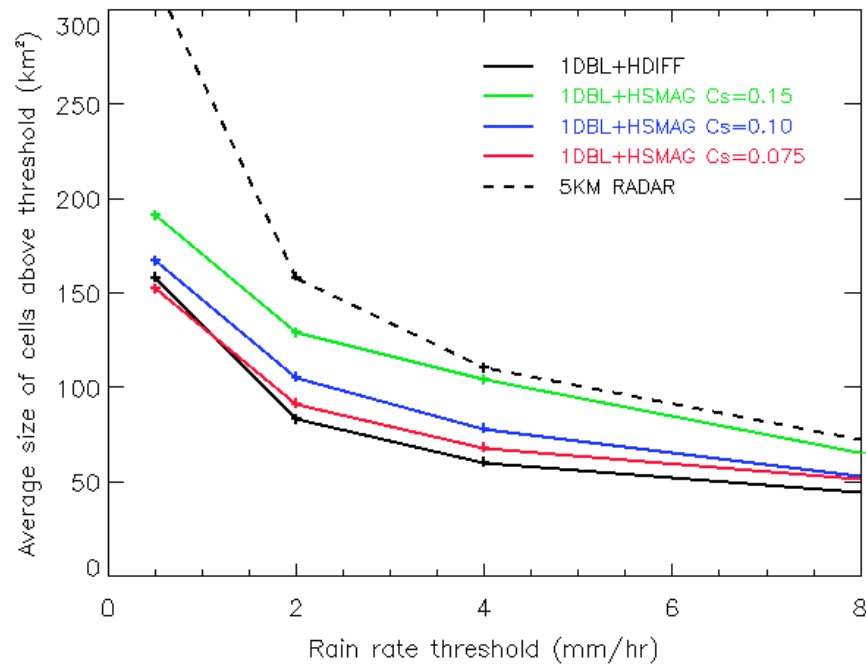

Average number of convective cells as a function of rainrate threshold

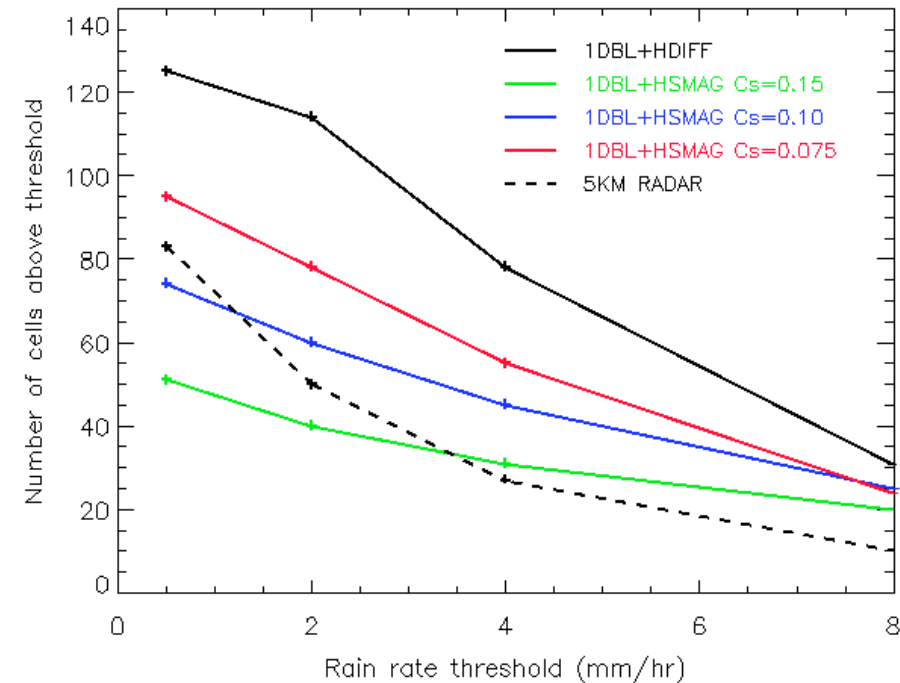

Model data is area-averaged to 5km radar grid



# Separate roles of horizontal and vertical mixing

Constant horizontal diffusion  $K=1430$

Vertical mixing in boundary layer promotes initiation

Horizontal mixing delays initiation but controls magnitude of deep clouds

Non-local boundary layer scheme in the vertical.

ConstDiff Coefficient:  
 $K=1430$ .

Max Diff for Cs runs:  
 $K=2086$ .

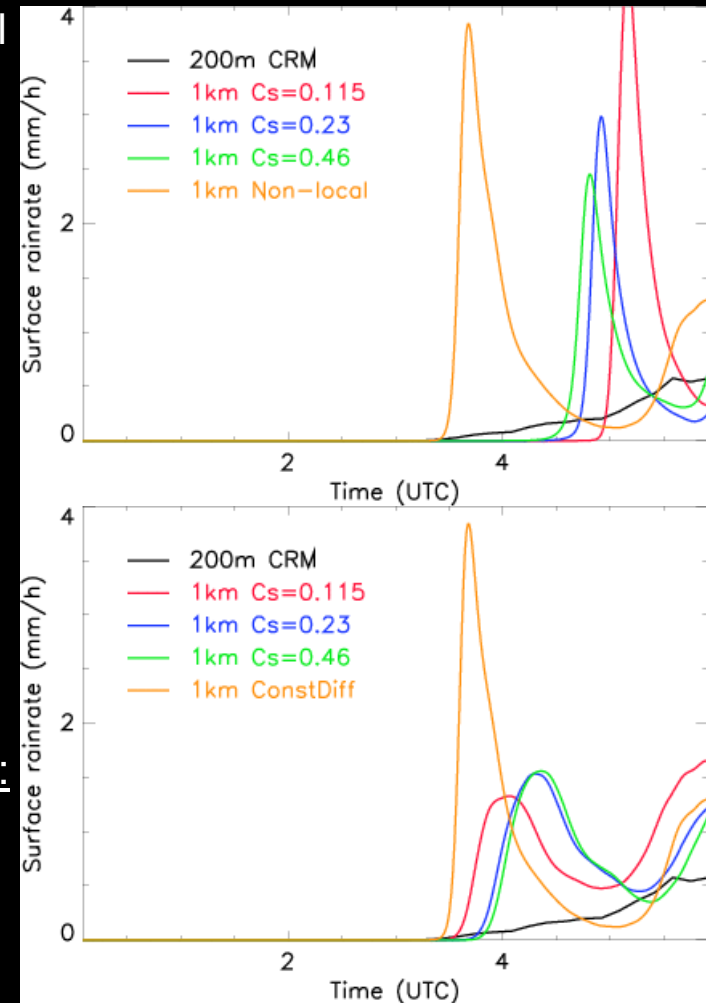

# A simple view of models

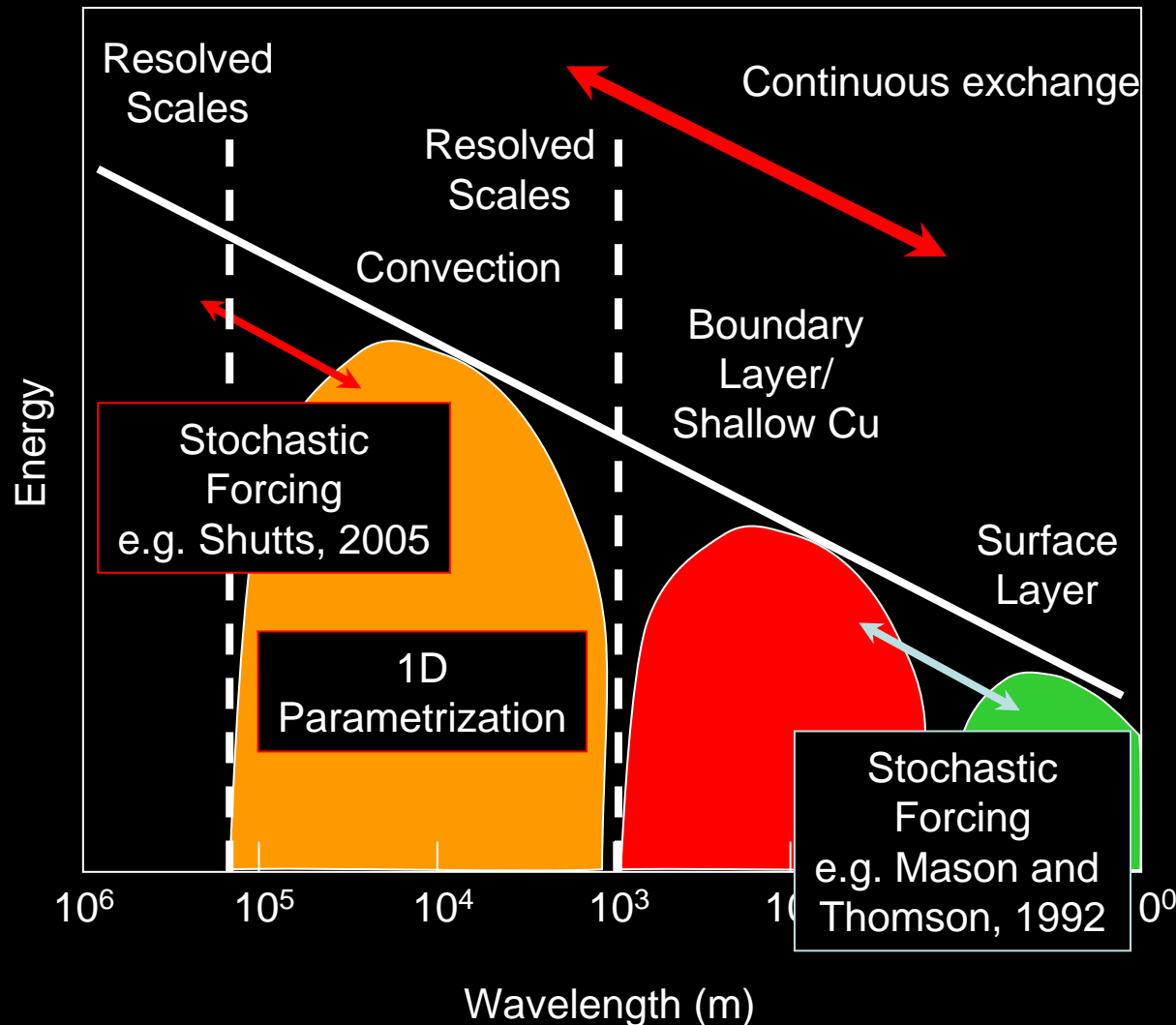

- Conceptual split by 'well-defined' phenomena.

- Artificial spectral gaps.

- Parametrization.





# Stochastic Backscatter in Diurnal Cycle

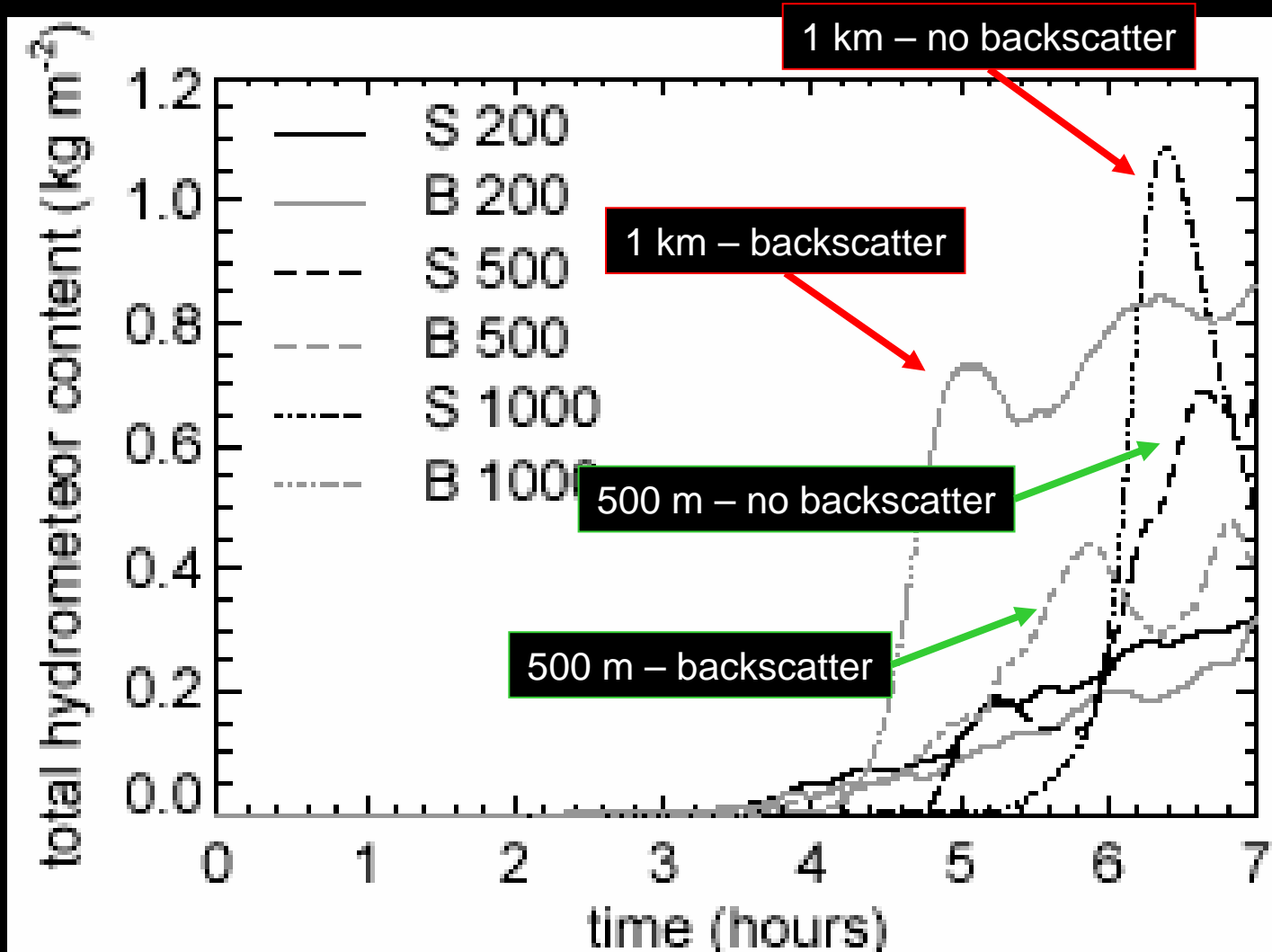



# Concluding remarks: priorities for ~ km scale models

- Surface schemes can be improved but we probably know how – main limitation is data.
- What are the prospects of affordable 3D radiation schemes?
- There remains plenty of scope to improve microphysics, esp. interaction with aerosols and ice nucleation but proving robust value of improvements will be hard.
- Treatment of turbulence is important for controlling initiation and nature of convective clouds. Currently a black art. Should be a focus of research.



Met Office



# Questions and answers



# Some comments on convection/turbulence parametrization

- The model does not 'know' about reality – if we impose a spectral gap or a filter, we are solving a different, but hopefully useful, problem.
  - We should not be surprised to get the 'wrong' answer when applying a scheme 'correct' at 100 m to a 1 km model (e.g. Bryan *et al*, MWR 2003). The issue is 'is our model still useful'?
- True 1D
  - Rest of model must ensure energy in smallest resolved scales close to zero to match assumptions in parametrization.
- Is our band-limited parametrization missing an important feature of the process? (e.g. de Roode *et al*, JAS 2004 on size of LES domain).
- 3D schemes in 'overlap' regime
  - Explicitly 3D
  - Prognostic variables (e.g. Garard & Geleyn, 2005).
  - Coupling to local dynamics (e.g.  $w$ -dependent triggering, as Kain-Fritsch) – depends on development of unstable  $w$  and hence horizontal (and vertical) mixing.
  - Do we understand how we control scales in parametrization? (e.g. Mason & Brown, JAS 1999)



# A simple view of models

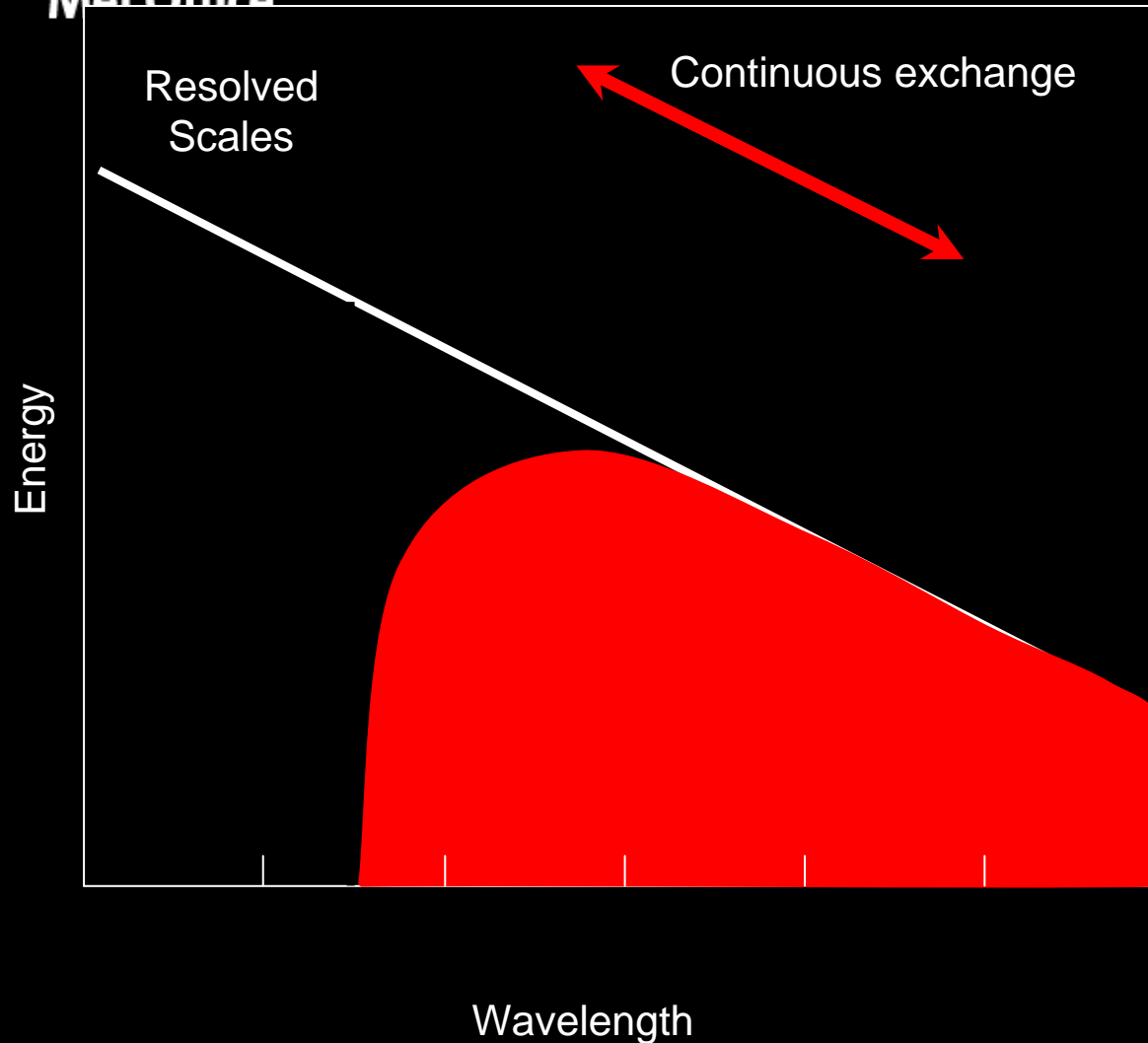

Parametrization  
'does everything'

- 1D ensemble mean treatment.
- Missing energy at 'interface'.
- Stochastic interface?



# A simple view of models

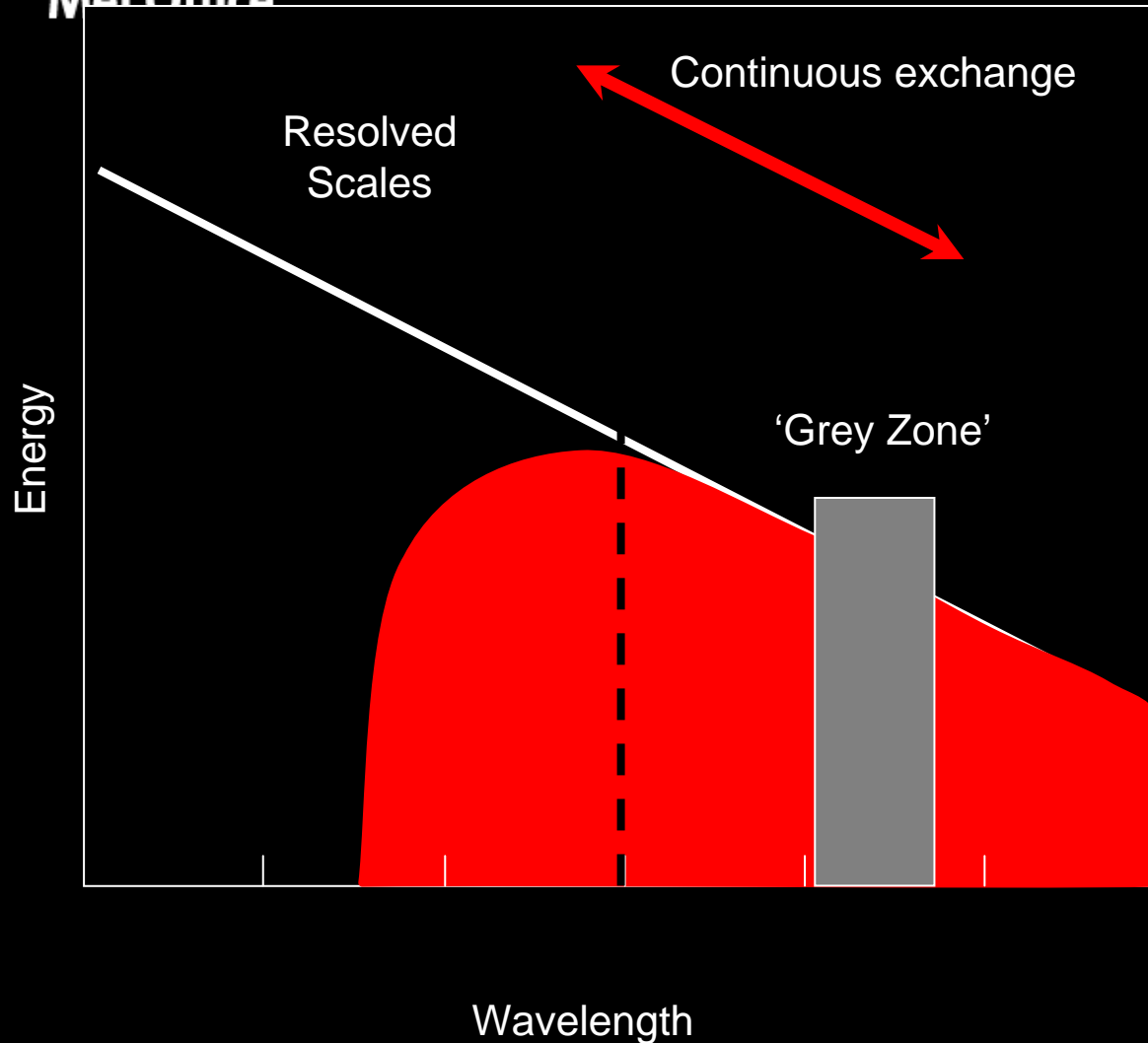

Parametrization  
'overlaps'

- 3D treatment (explicit or implicit).
- Ensemble treatment + 'sampling error'.  
or
- Stochastically forced low order coherent structures.