



Diagnostics of the Extratropics

John Methven, Department of Meteorology

Diagnostics vs prognostics

Diagnosis: determine properties of current state (of atmosphere) given observations now and in recent past.

Involve eqns relating variables at one instant in time.

Prognosis: forecast properties based on a diagnosis of the current state.

Integrating eqns with time derivatives.

There are endless ways of diagnosing the atmosphere (e.g., correlating temperature in Reading with surface pressure in Iceland).

But, the most useful diagnostics are those which relate to conceptual and theoretical models of the way in which atmosphere *evolves*.

Even if a complex numerical model is required to produce an accurate forecast, powerful diagnostics enable us to anticipate what will happen next and to understand model failings.

Talk Outline

Diagnostics are complicated by the **non-local** nature of the atmosphere

1. Long-range transport of nearly conserved properties by winds.

2. Balance between variables, mediated by fast wave propagation
⇒ action-at-a-distance.

3. Eddy-mean flow interaction
Depends on form of average used to define background.
“Eddy” could mean wave or coherent structure such as a vortex.

Caveat: figures are drawn from material I know well and is not a comprehensive review.

Refer to proceedings paper for full references.

1. Transport diagnostics

Winds are 3-D and time-varying, but dominated by larger scales

⇒ *chaotic advection* where trajectories of air masses are sensitive to initial conditions and separate exponentially on average.

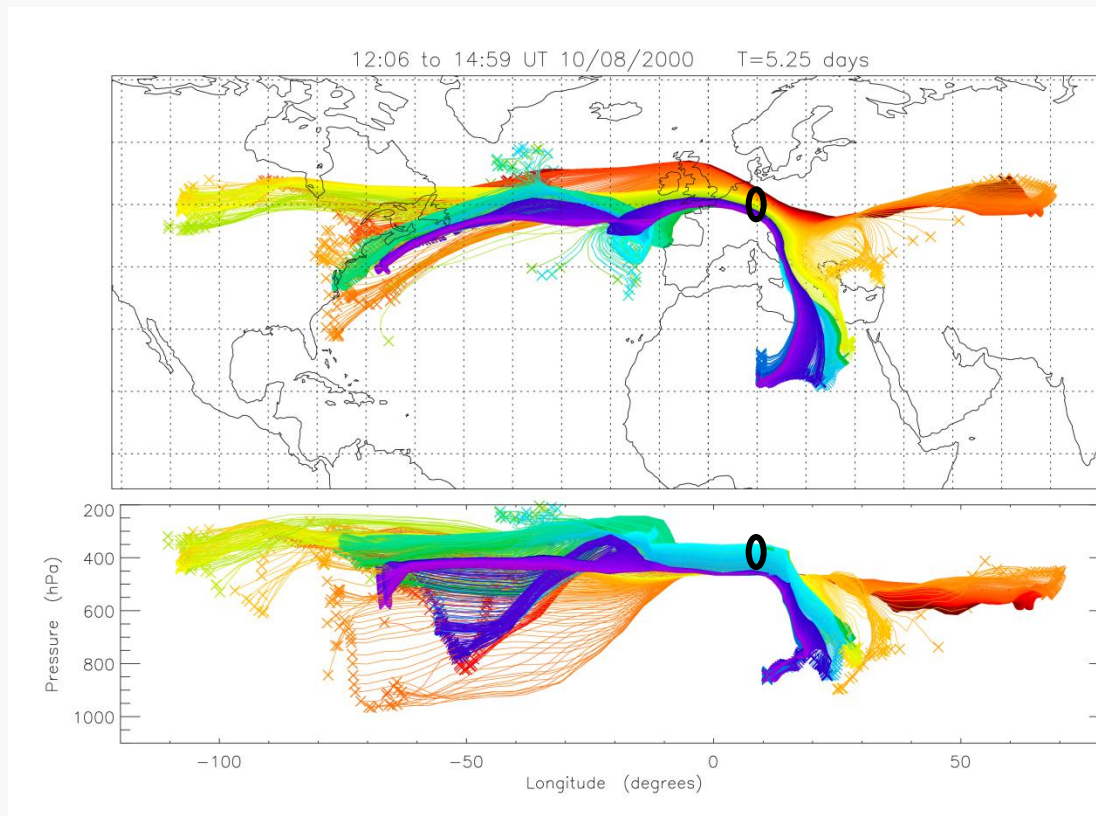

Example:

Trajectories calculated forwards and backwards in time (for 5 days) from an aircraft flight track.

Note sampled air originates from a wide area and also spreads into a wide area.

Numerical integration of

$$\frac{D\underline{x}_i}{Dt} = \underline{u}(\underline{x}_i(t), t)$$

Where winds from ECMWF analyses.

Are trajectories predictable?

Can observe chemical and thermodynamic tracers with aircraft to establish air-mass identities.

BUT need to forecast air-mass trajectories in order to direct aircraft to intercept the same air several times over a long range.

Motivation for the ITCT-Lagrangian 2K4 Experiment which took place within the framework of the ICARTT campaign in summer 2004:

- Sample polluted air masses leaving the continental BL.
- Follow across Atlantic since no emissions after USA.
- Deduce chemical transformation en route.
- Scale of problem requires several coordinated research aircraft.

JGR, ICARTT special issue

Fehsenfeld *et al* [2006] – campaign overview

Methven *et al* [2006] – Lagrangian experiment

e.g., New York to Spain – 4 flights linked by trajectories to Azores

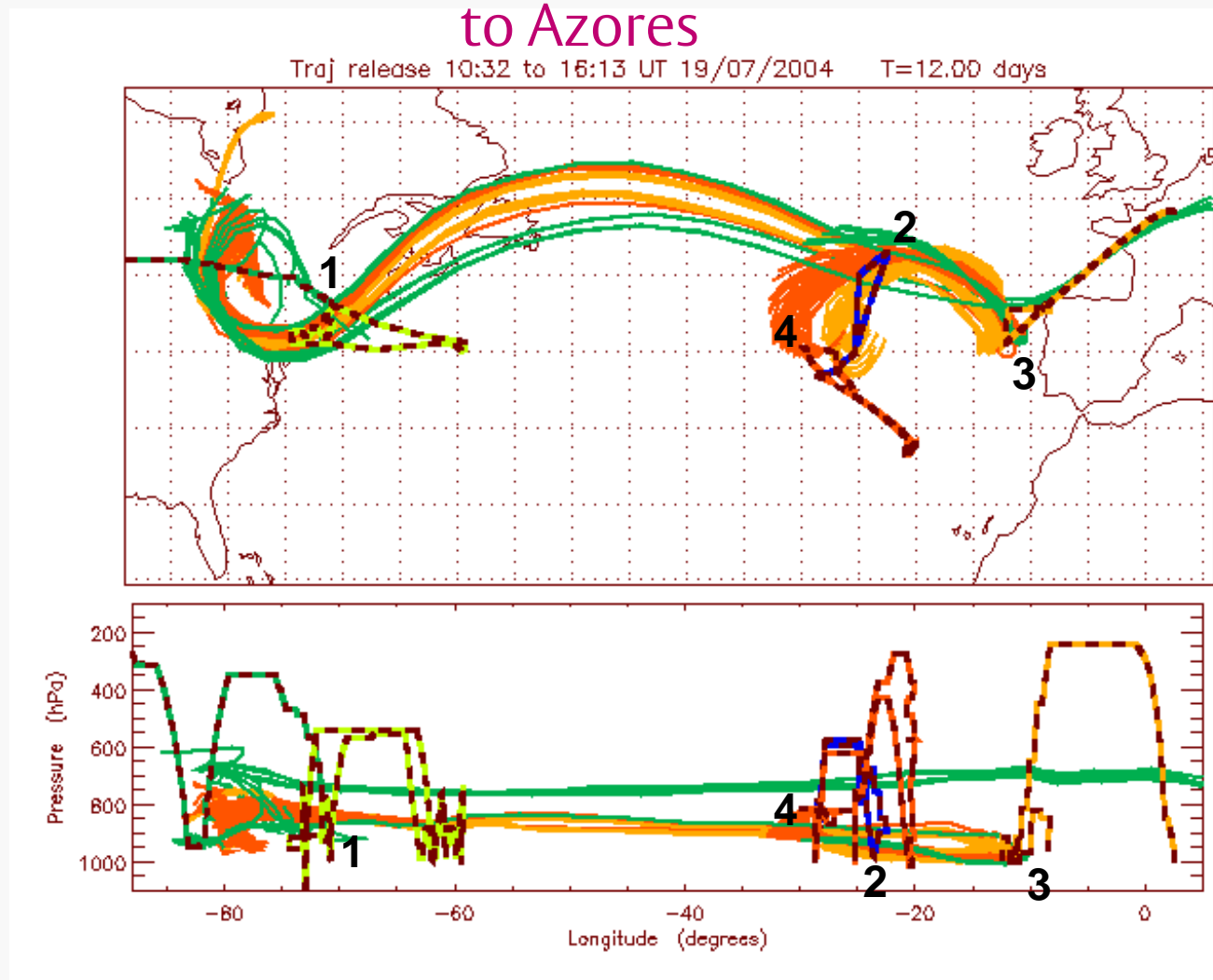

Trajectories from BAE146 flight track (blue) back and forwards for 3.5 days.
Best matches with trajectories from other flight tracks.

+3

Did the aircraft sample the same air mass many times?

Two independent matching methods:

1. Trajectory models driven by met. analyses
2. Hydrocarbon fingerprints (bottled air samples)

Search for *coincident* matches:

two samples with matching HC fingerprint are also linked by matching trajectories.

Quality of matches assessed using independent observations of thermodynamic tracers

Lagrangian match quality evaluated with temperature and humidity observations

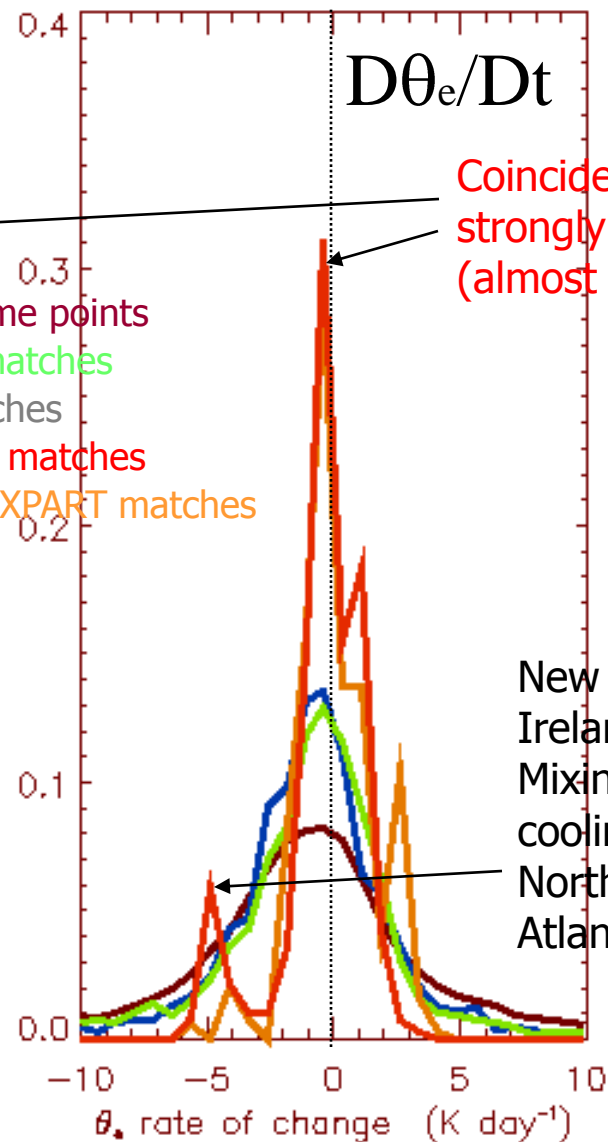
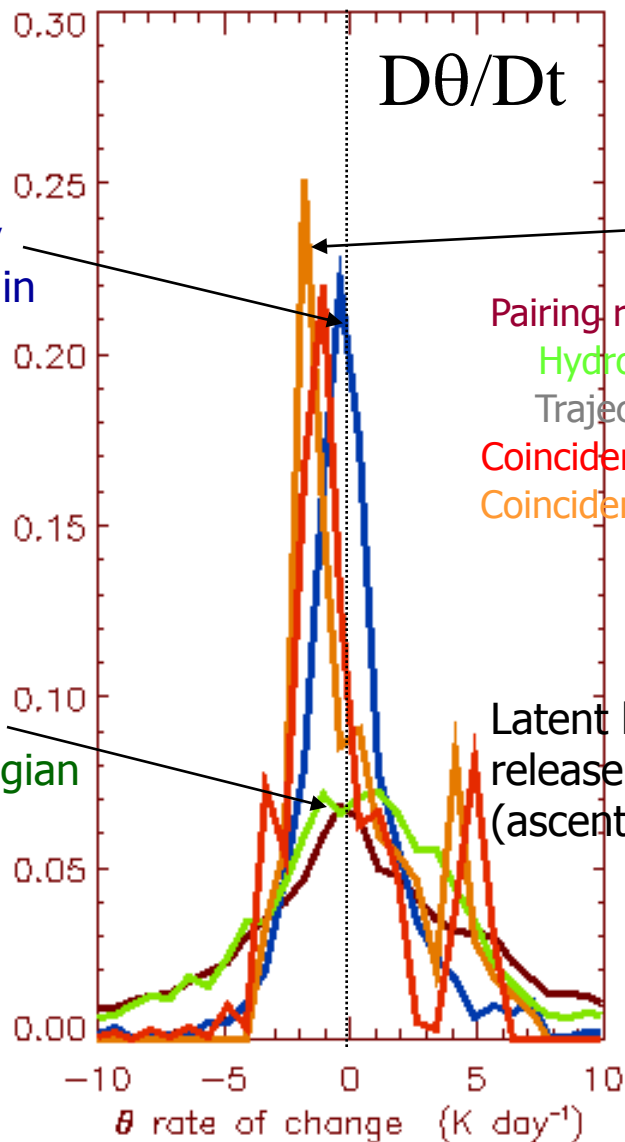

Trajectory-only matches good in theta. Analysis close to obs.

Matching HCs alone does not make a Lagrangian match

Pairing random time points
Hydrocarbon matches
Trajectory matches
Coincident HC/traj matches
Coincident HC/FLEXPART matches

Latent heat release (ascent).

Coincident matches strongly peaked (almost adiabatic)

New York - Ireland. Mixing and cooling in North Atlantic MBL.

NY-Spain-Azores photochemistry simulation

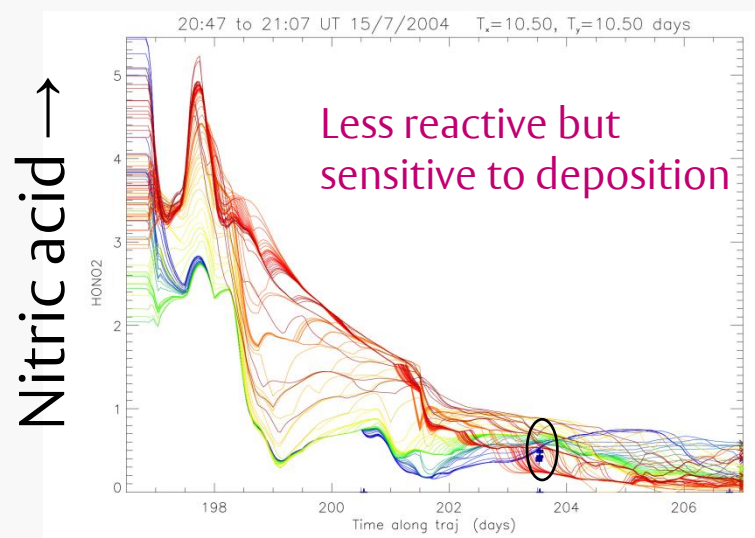
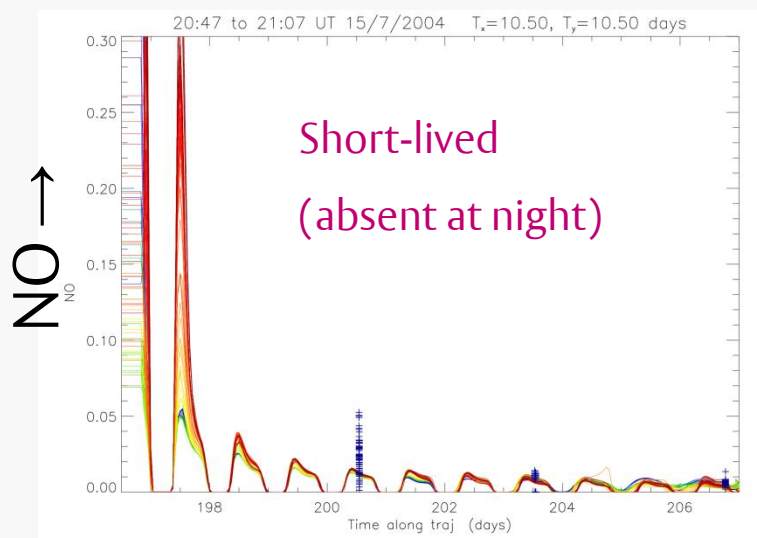
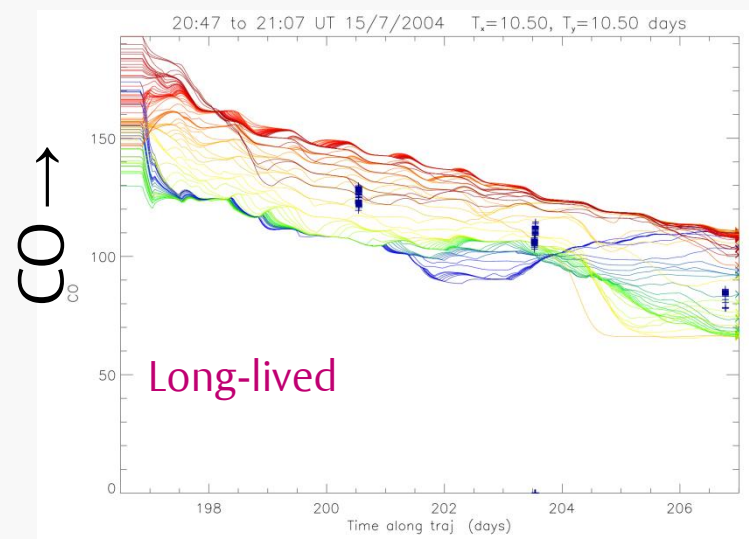
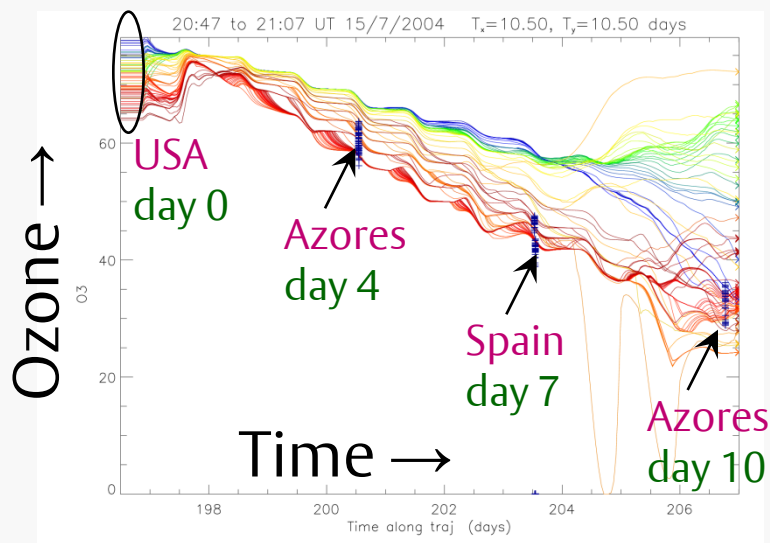

Why are trajectory calculations so accurate?

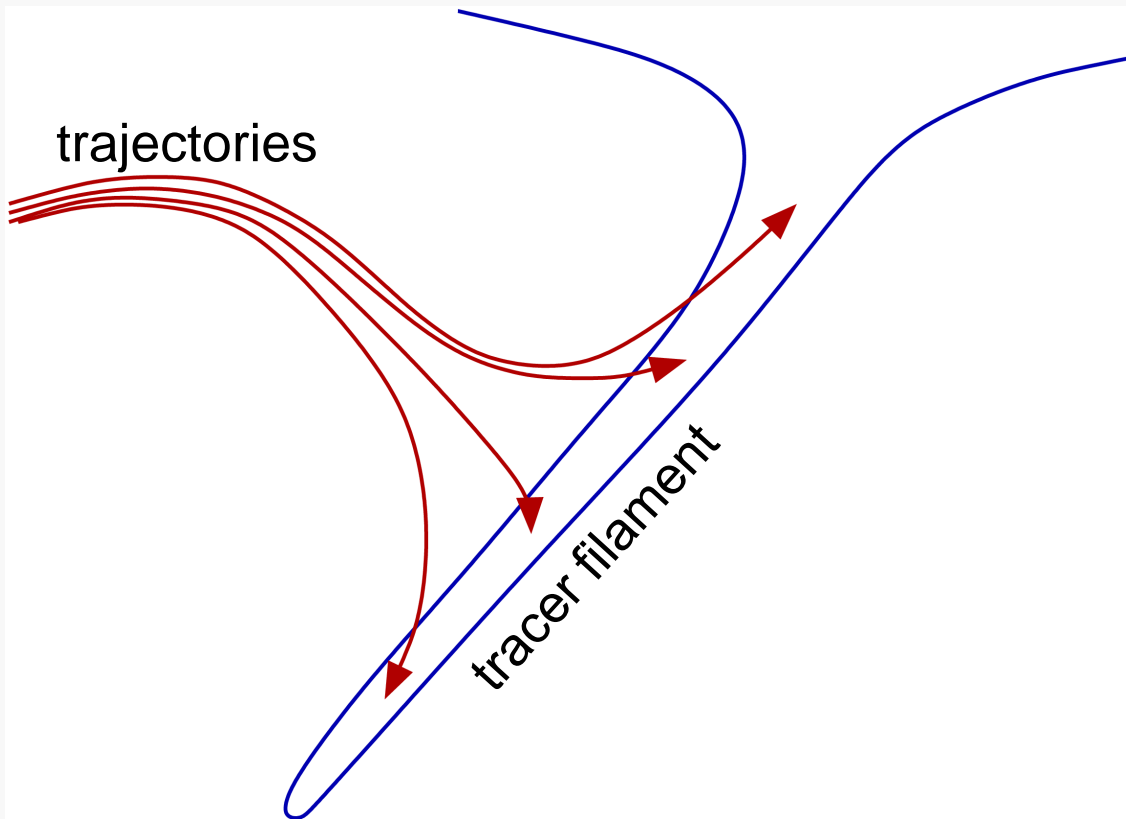

Chaotic advection \Rightarrow tracer “cascades” to small scales.

Occurs even though winds are dominated by large scales.

Can we use low resolution winds?

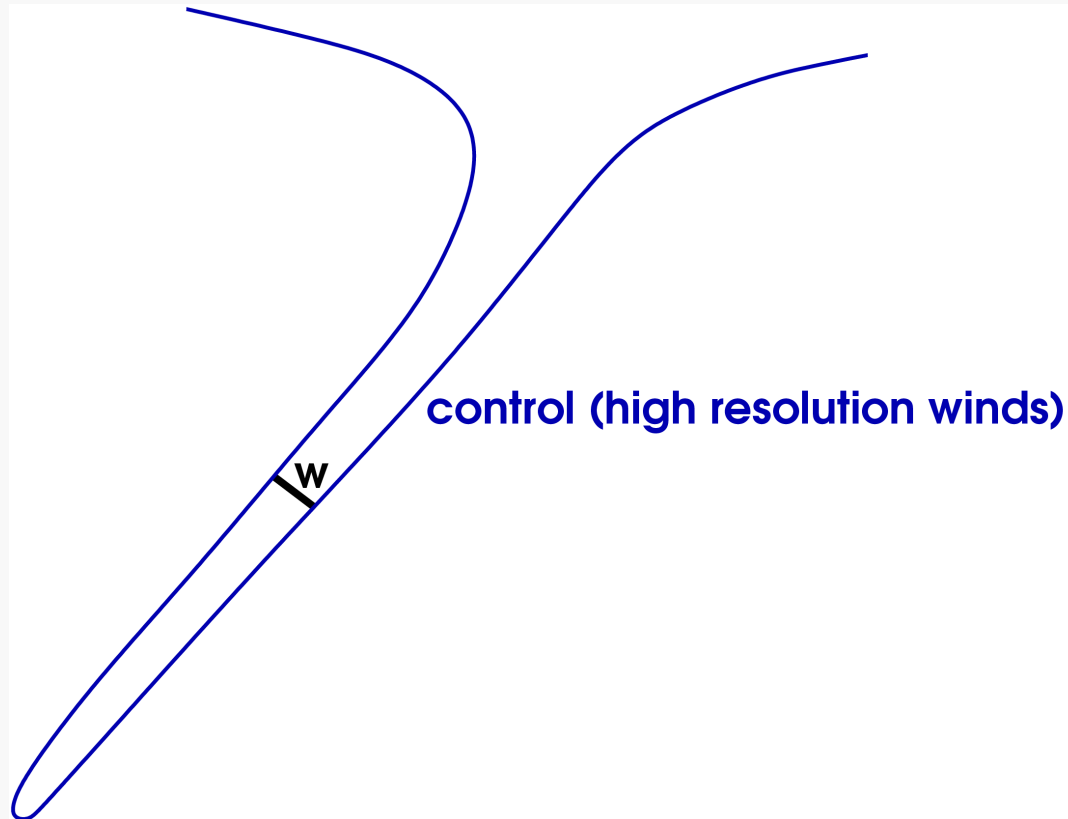

Can we use low resolution winds?

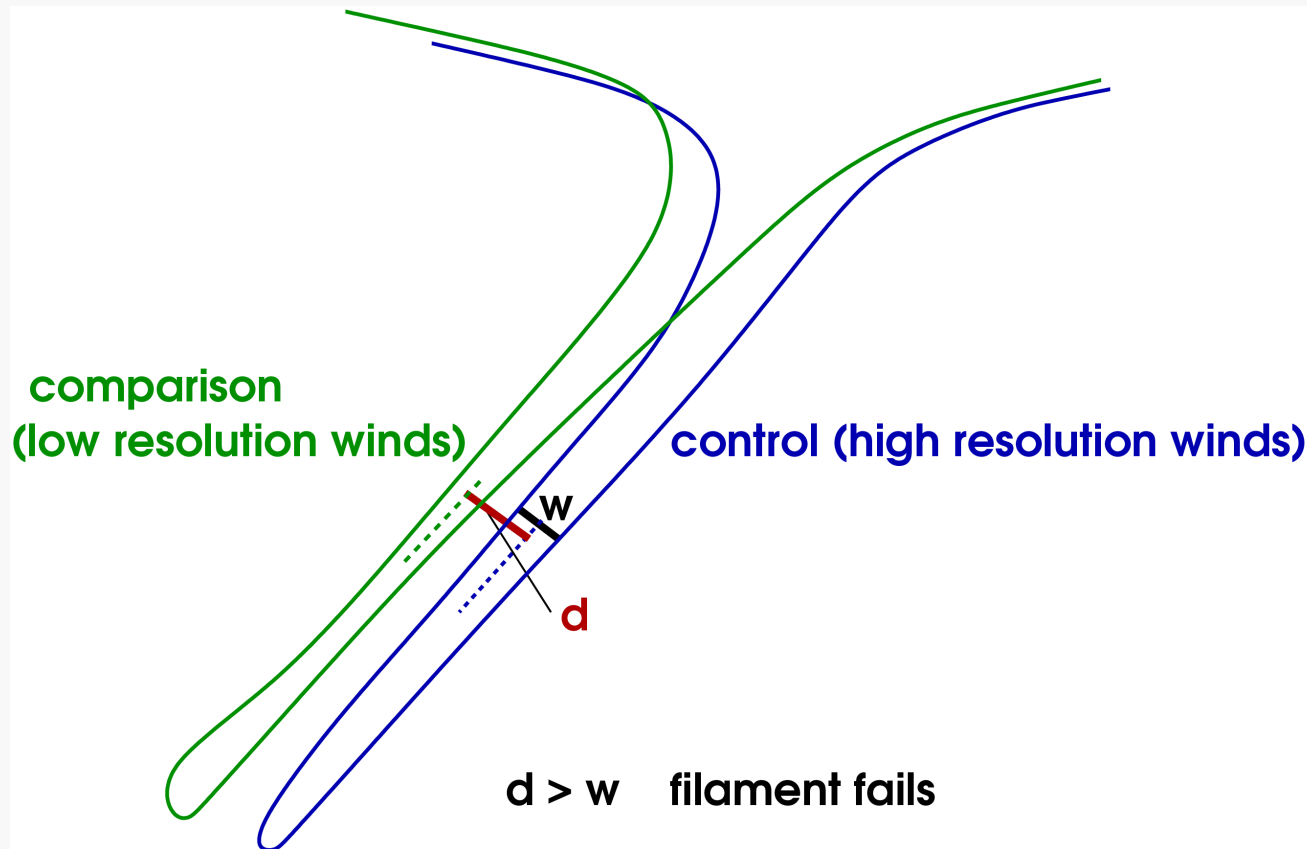

$$\text{Tracer scale factor} = \frac{\text{Smallest resolved scale in winds}}{\text{Width of widest failed filaments}}$$

≥ 6 for mid-lat weather systems and stratosphere

\Rightarrow Lagrangian models are accurate

Methven and
Hoskins (1999), JAS

Reverse domain filling trajectories

Finescale tracer structure can be diagnosed by calculating many back trajs from a dense 3-D grid and colouring each grid-point by value of tracer at origin.

e.g., Sutton *et al* [1994], JAS

Back trajectories from points A, S and E on section XY

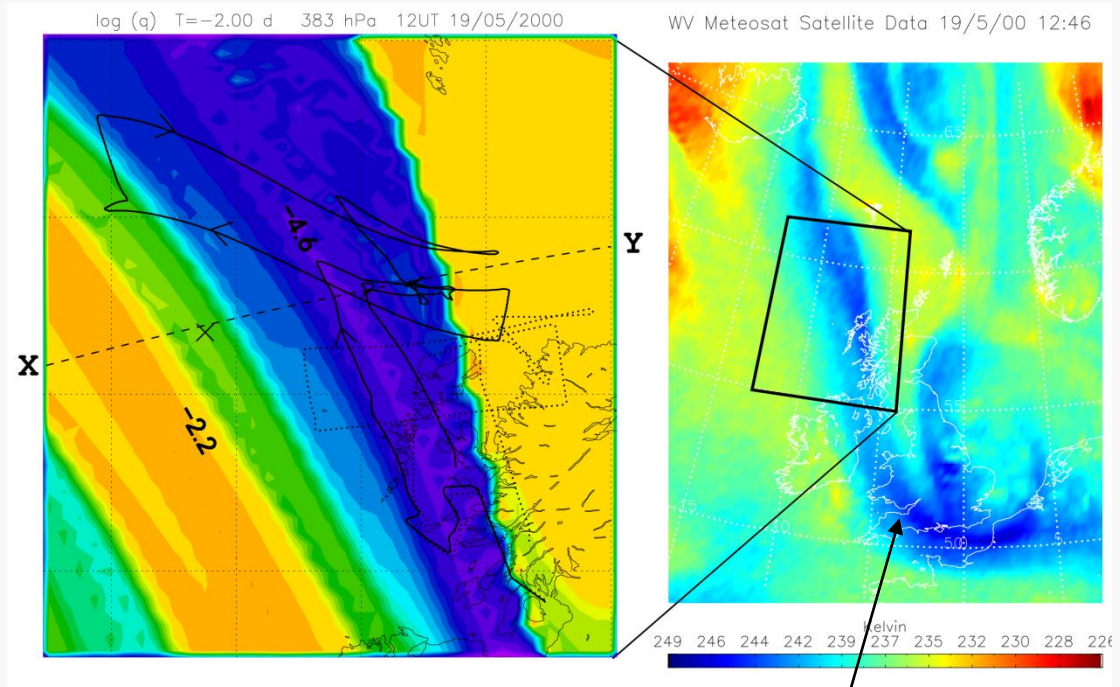
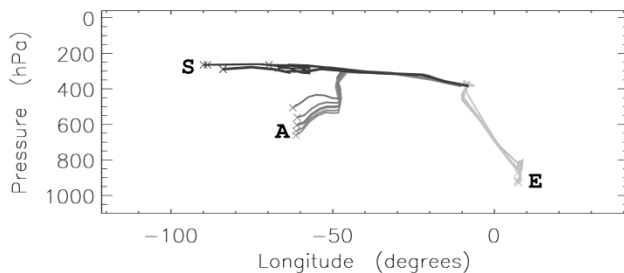
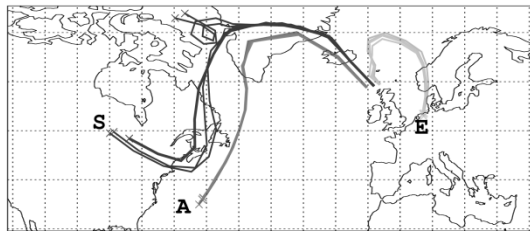

RDF trajectory analysis of specific humidity

Based on 1.5 day sequence of ECMWF analyses

$\chi(T)$ log(q) T=-1.50 d 12UT 19/05/2000 (F+0.0d)

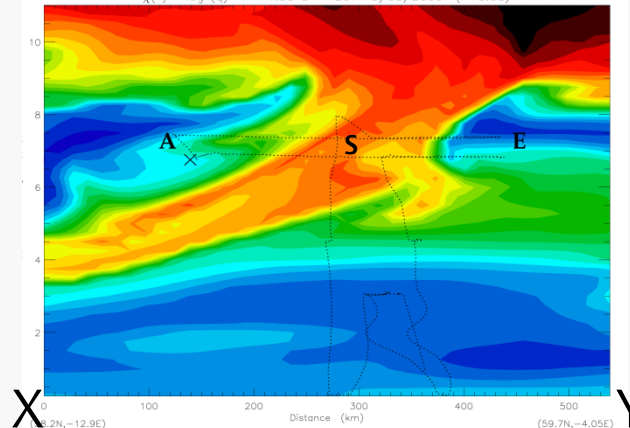

Meteosat WV chan dry intrusion

Sampled using MRF aircraft in 2000.
Methven *et al* [2003], JGR

Is finescale structure accurately represented?

RDF trajectory analysis of specific humidity

Based on 1.5 day sequence of ECMWF analyses

$\chi(T)$ $\log(q)$ $T=-1.50$ d 12UT 19/05/2000 (F+0.0d)

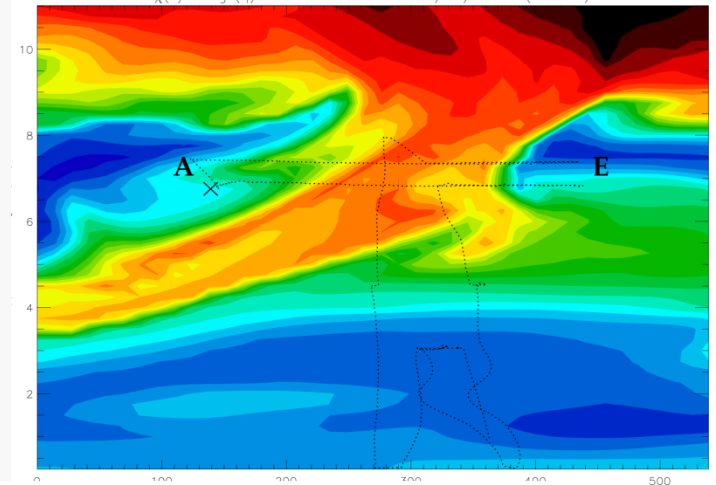

(59.7N, -4.05E)

19/05/2000

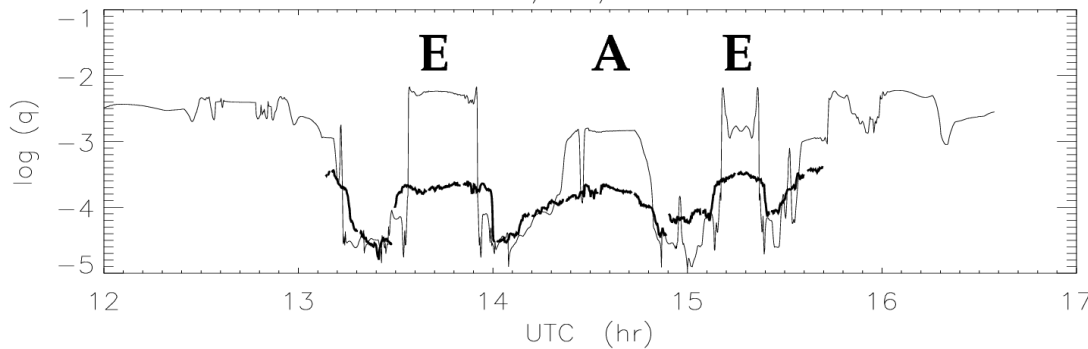

19/05/2000

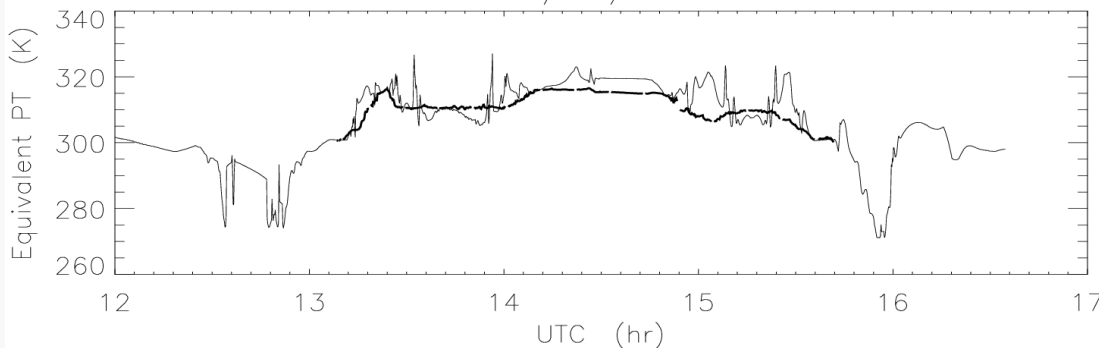

MRF instruments
on aircraft

Simulated using
trajs arriving
along flightpath

Allowing for non-conservation

- RDF trajectory reconstructions assume tracer conservation.
- Strong gradients arise as air masses of different origins are brought together by strain flow (tracers are long-lived relative to Lagrangian decorrelation timescale ~ 1 day in mid-lats).
- As trajectory length in time increases, RDF structure becomes increasingly finescale until unrealistic.
- Relevant trajectory length is determined by non-conservative processes following air-masses.

⇒ Next level of sophistication is to use simple models along trajs.

Application for water vapour.

(e.g., Sherwood [1996], *J.Clim.*; Pierrehumbert and Roca [1998], *GRL*)

Advection-condensation model (1)

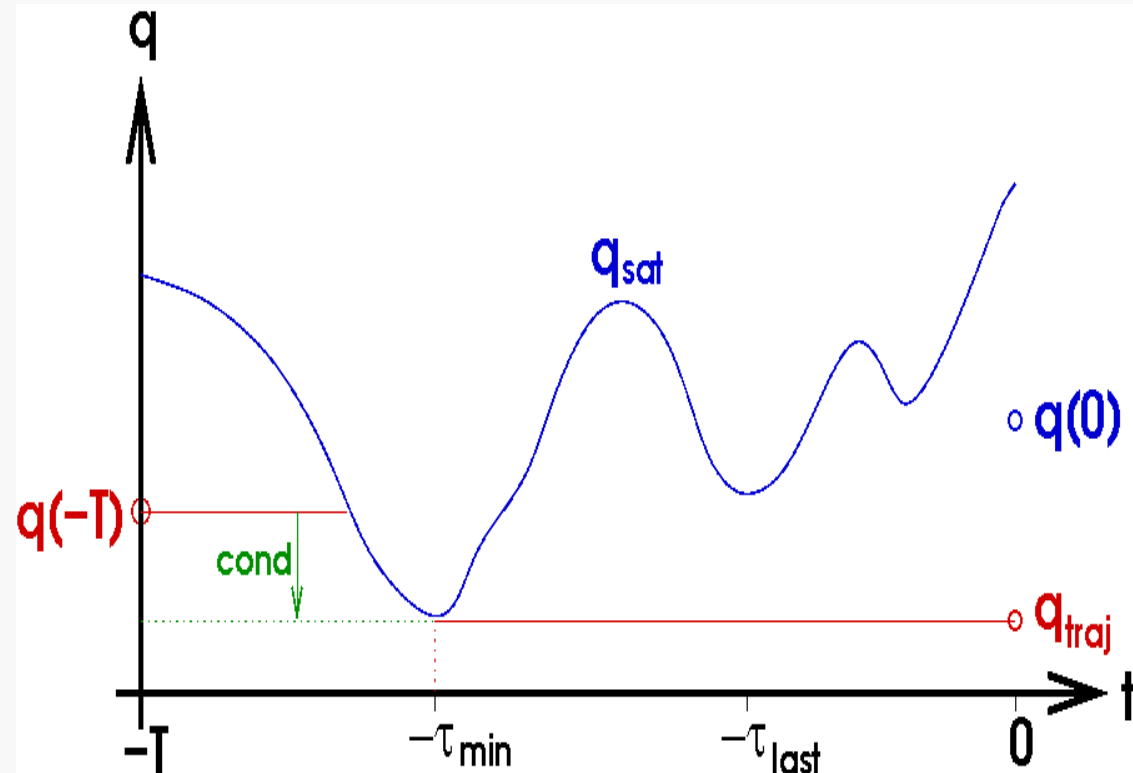
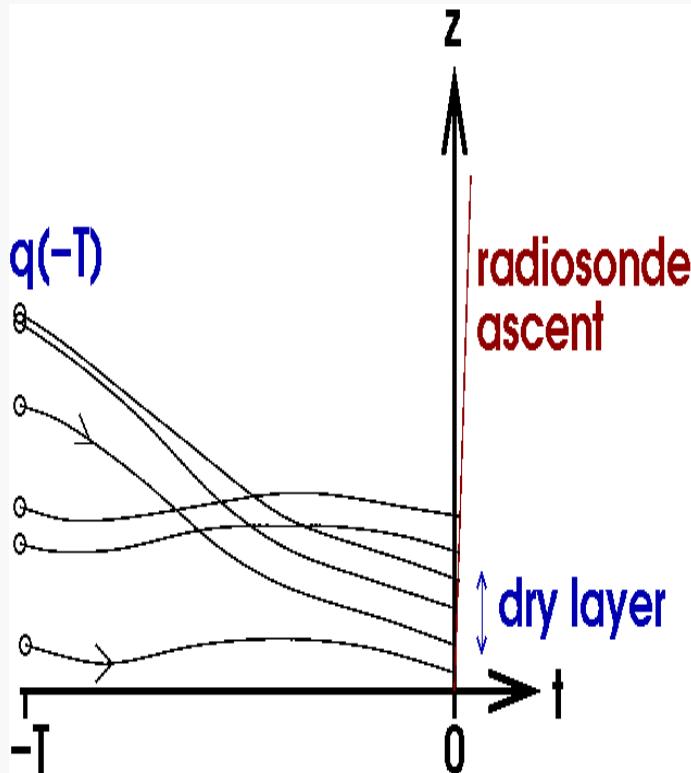

Back trajectories from coordinates of radiosonde.

T, q interpolated from analyses to trajectory coords.

$$q_{\min} = \min[q_{\text{sat}}] \quad (\text{occurs at } t = -\tau_{\min})$$

$$q_{\text{traj}} = \min[q(-T), q_{\min}]$$

grey areas

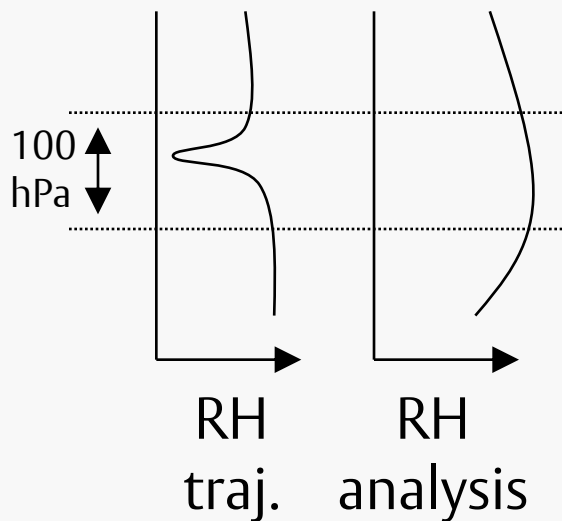

Sonde observations of RH in TOGA COARE expt

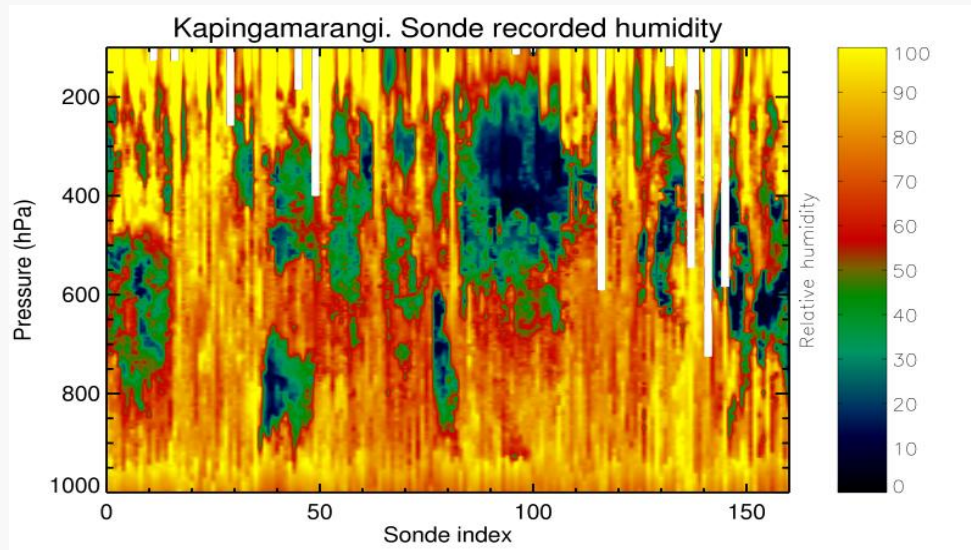

black areas

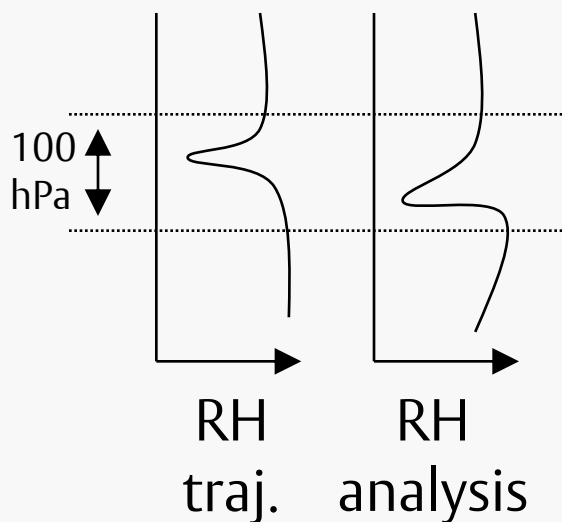

Dry events simulated using trajectories

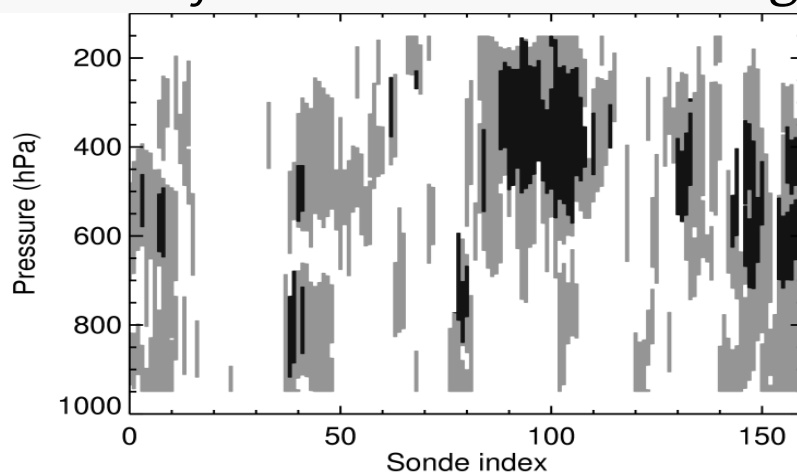

Cau, Methven and Hoskins (2005), *JGR*, 110, d06110

Advection-condensation model (2)

Model allowing for re-moistening implicit in analyses

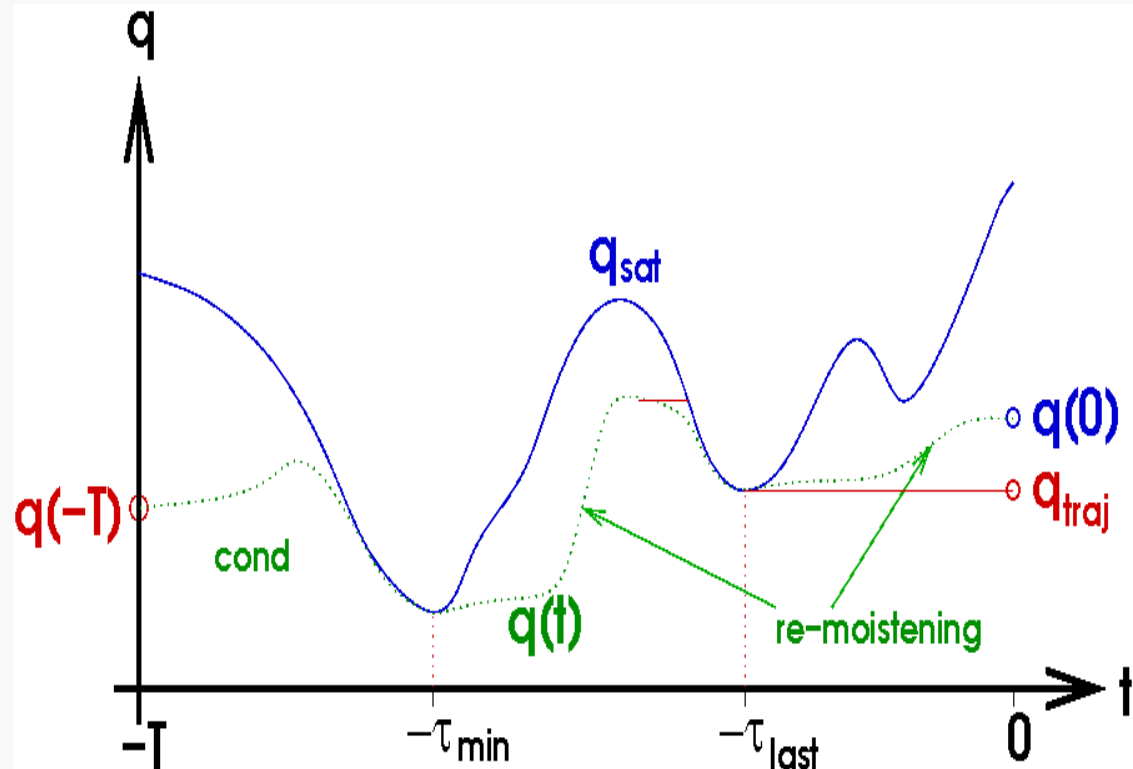

$$q_{\text{traj}} = q_{\text{sat}} \text{ at last condensation, } t = -\tau_{\text{last}}$$

$$q_{\text{traj}} = q(-T) \text{ if saturation does not occur}$$

Time since last condensation

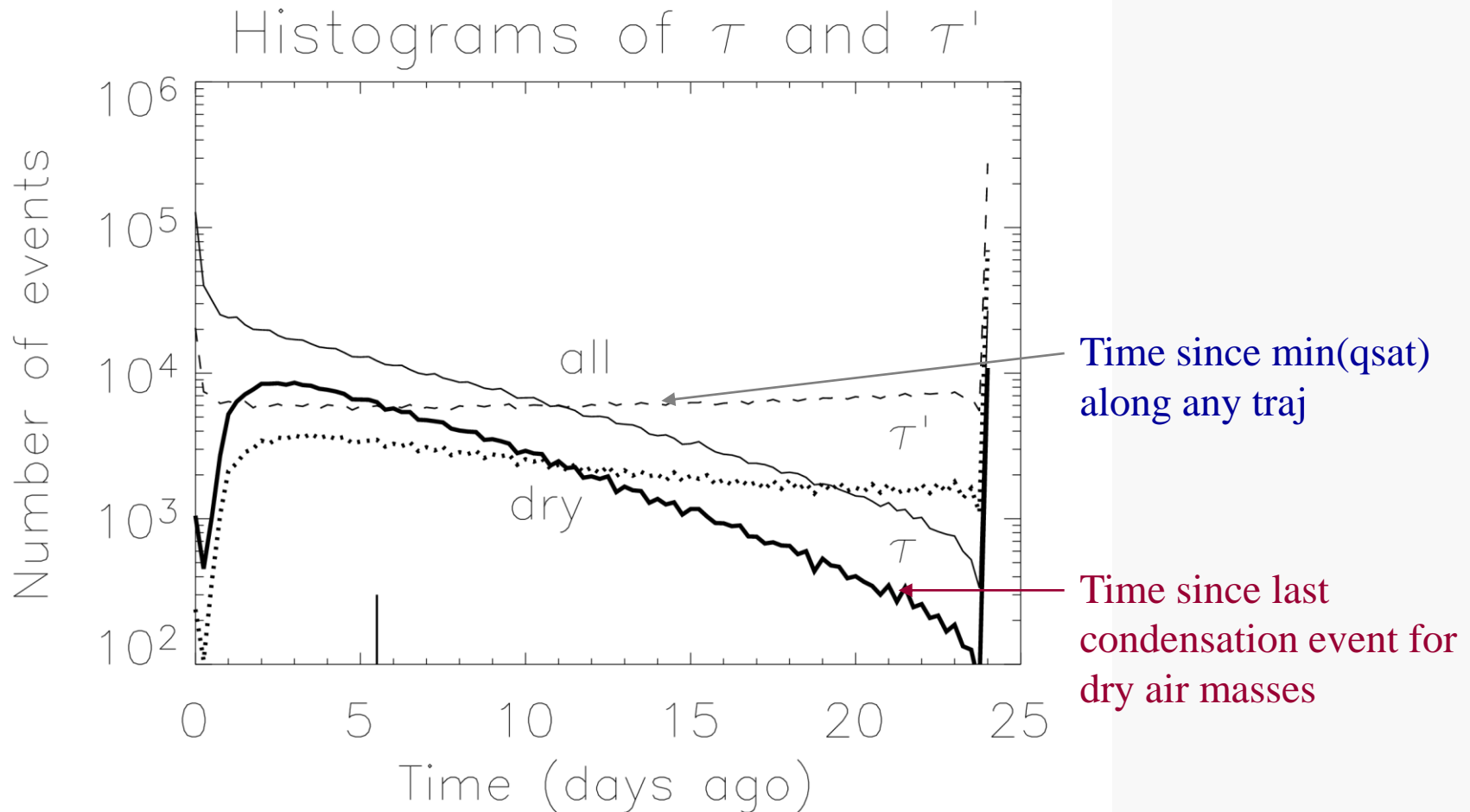

$\min(q_{\text{sat}})$ equally likely to occur at any time along a traj.

Last condensation most likely 2-3 days before dry event.

Trajectory statistics

- Trajectory ensembles from a small volume rapidly diverge and can cross.
- Even trajectories from a point will form a tangle if collated over time.
- Hard to visualise typical trajectory behaviour.
- One approach is to identify special events along trajectories (e.g., time of last condensation) and create number density distributions characterising location of events.
⇒ discarding information about complex path between the event and trajectory release point.

Preferred regions for condensation

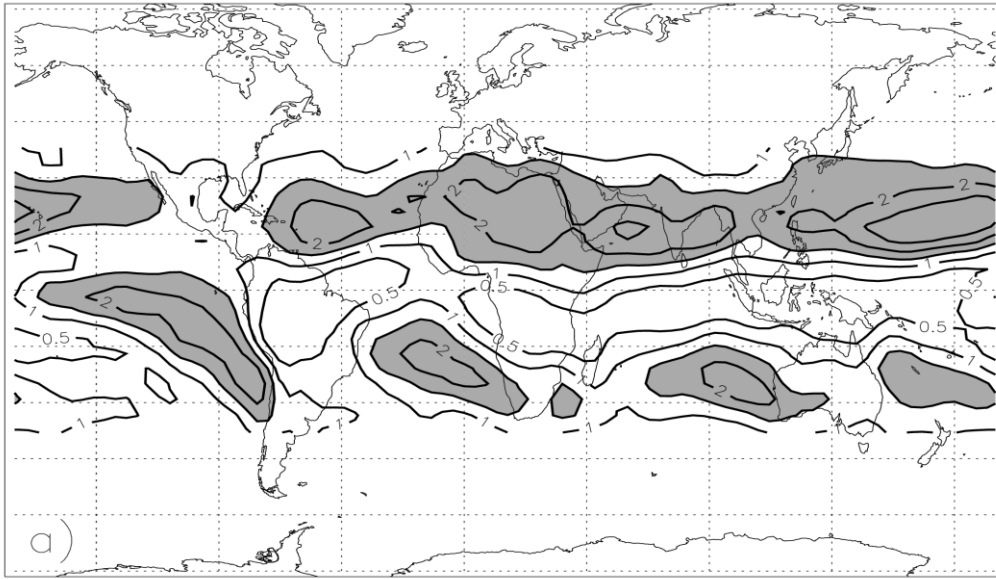

Dry regions in subtropics

Number density of dry events (RH < 20%) at all levels during Jan 1993.

Integrates to one over sphere.

Zero outside 40S-40N band.

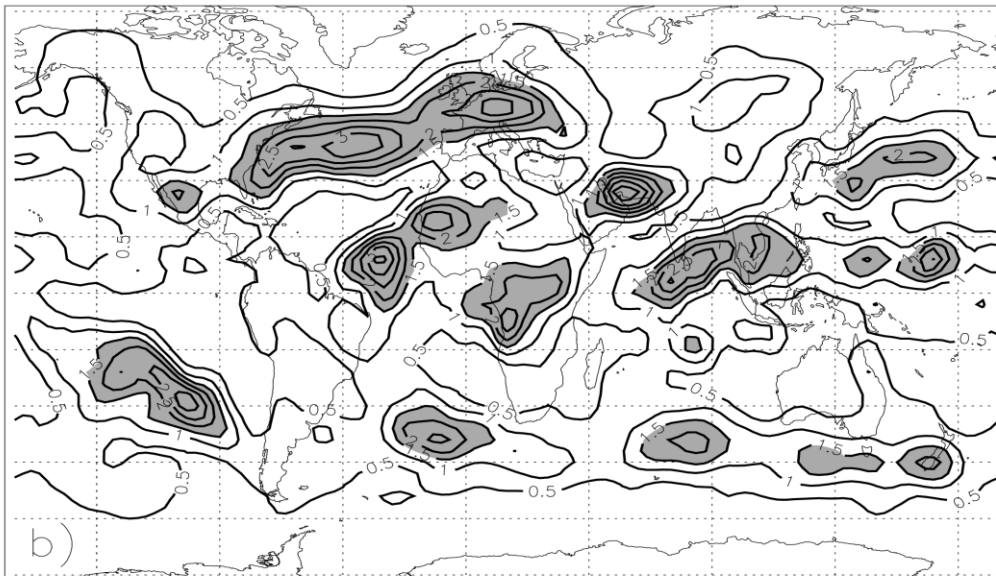

Number density of last condensation events.

“Density of origin” for dry air arriving in 40S-40N band.

Far from uniformly distributed and often in extratropics.

Origins for isolated dry regions

b)

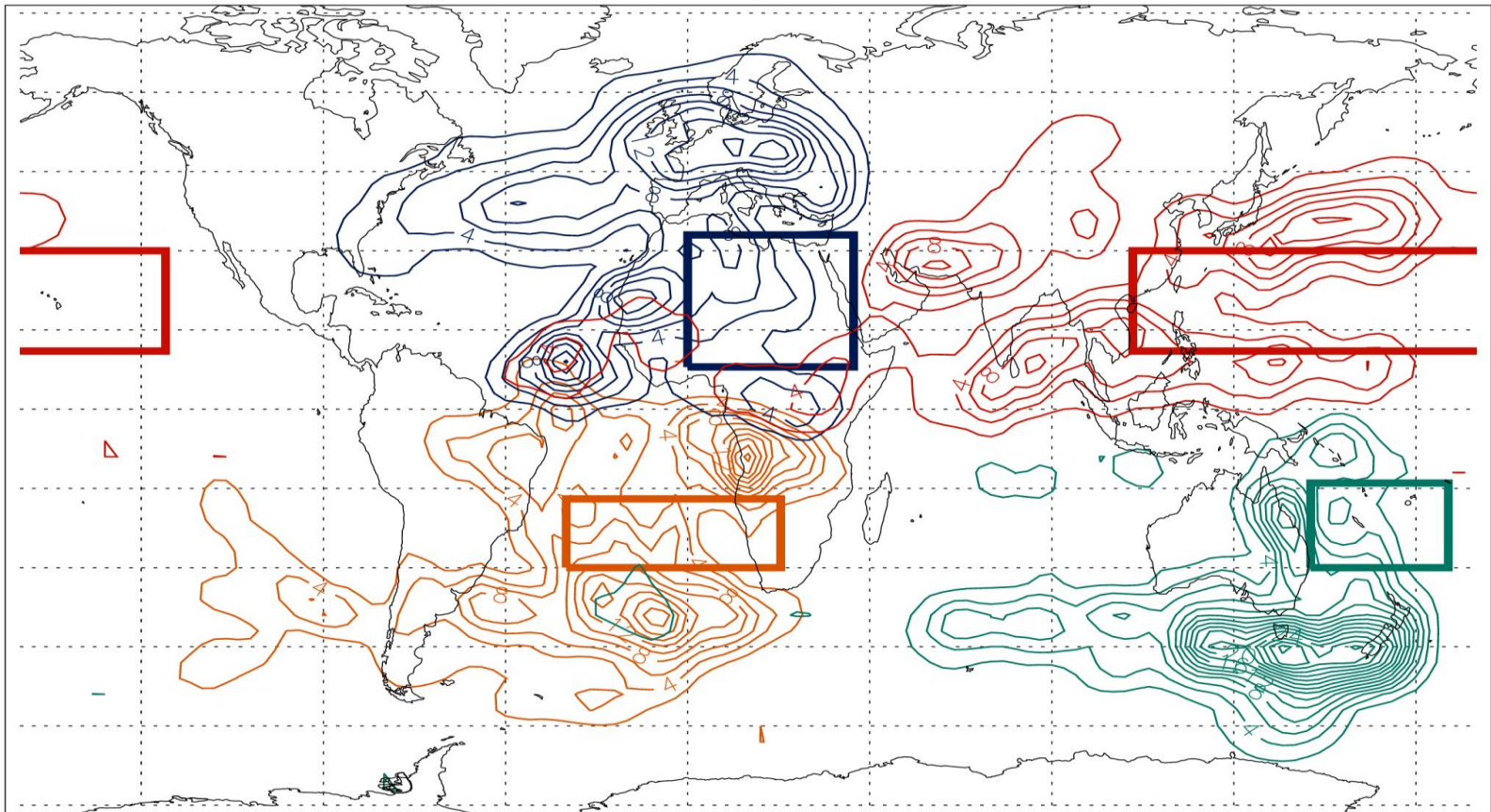

Dry regions are isolated by boxes.

Contours show corresponding density of origin.

Many contributors to each dry region.

Destination of air saturating in isolated regions

b)

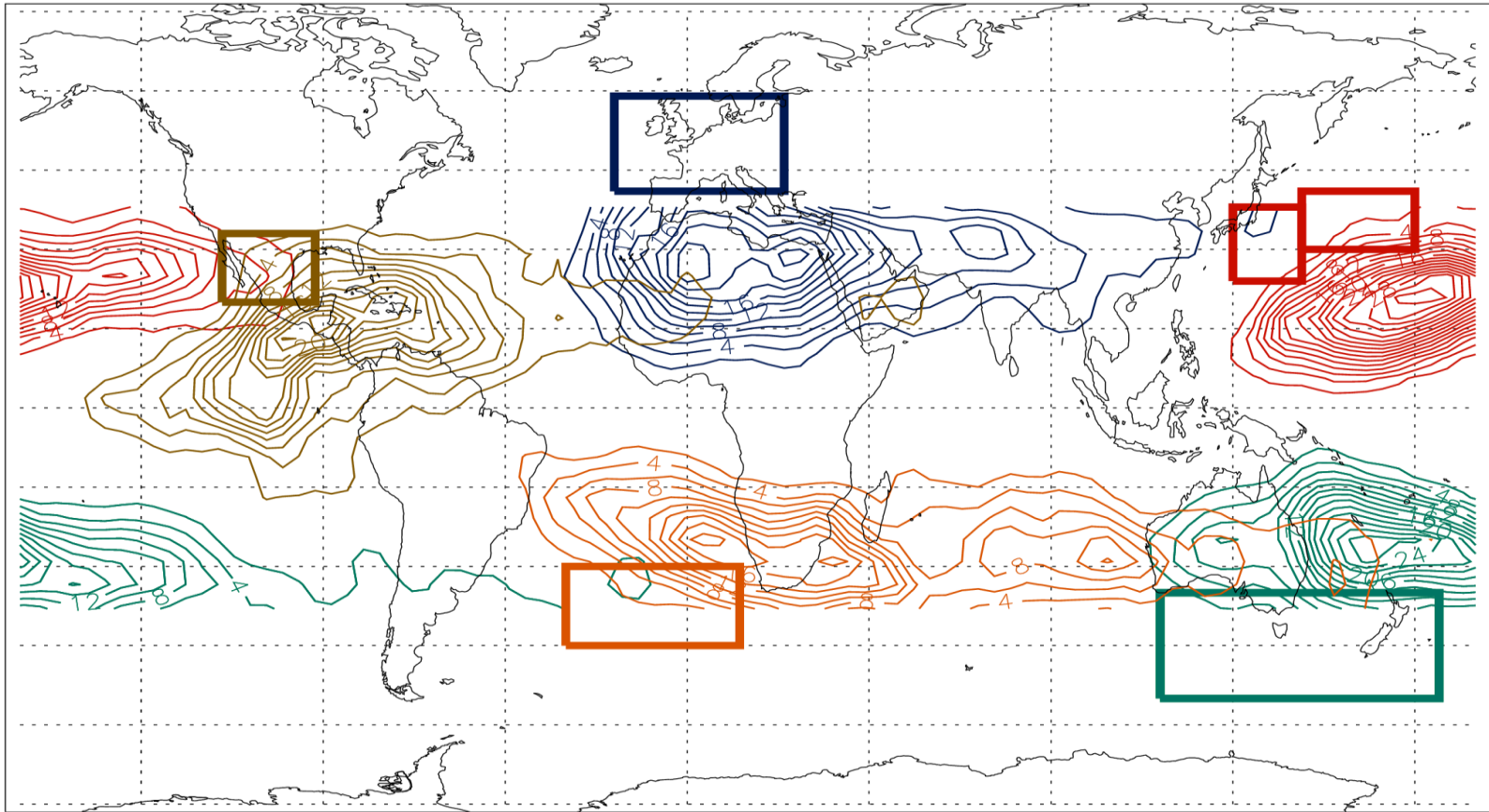

Condensation events within isolated boxes.

Contours show arrival locations of these dry air masses.

Each condensation region contributes to one/two dry regions.

Transport processes linking dry air to its origins

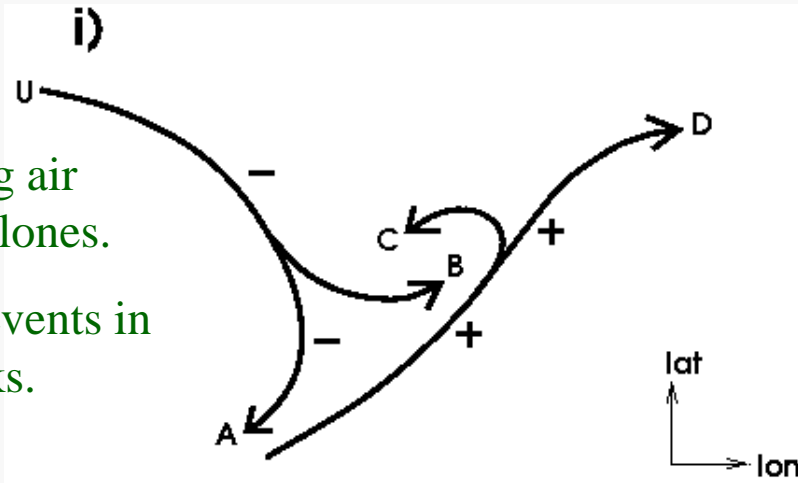

Descending air behind cyclones.
Transient events in storm tracks.

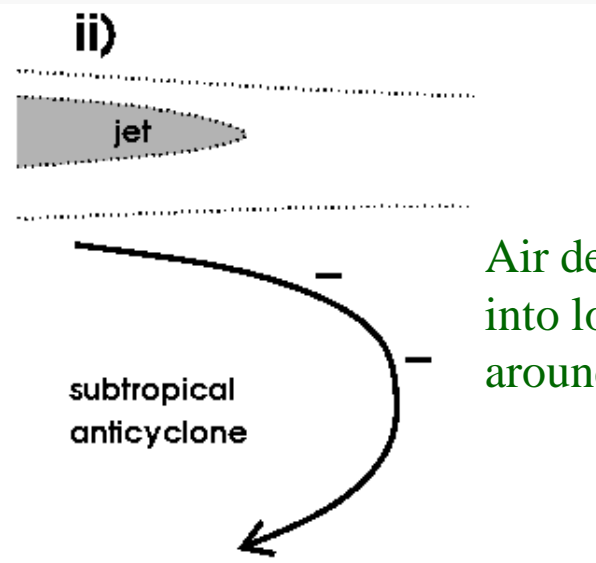

Air descending into lower trop around A/C

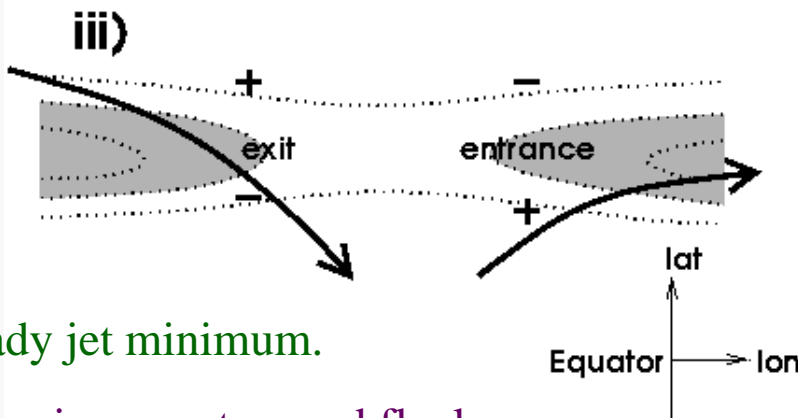

Nearly steady jet minimum.
Descent crossing equatorward flank of jet exit from UT.

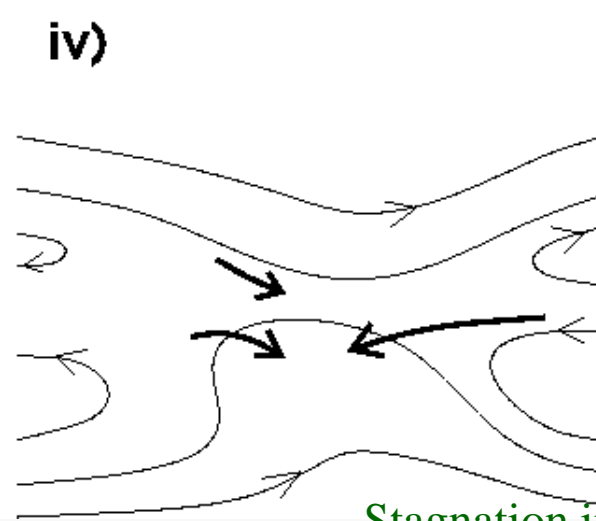

Stagnation in UT over tropical Atlantic

Ascent into jet entrance in UT, then radiative descent in jet.

1. Conclusions on Transport

- Trajectory calculations are surprisingly accurate.
- Verification with observations is difficult, but possible using tracers.
- Trajectories are sufficiently predictable to conduct Lagrangian aircraft experiment.
- Finescale tracer structure can be reproduced using reverse domain filling trajectory calculations for 3D domains – used forecast mode during aircraft campaigns.
- Simple advection-condensation models enable diagnosis of the water vapour distribution and the “origin” of unsaturated air.
- Number density distributions are useful reduction of Lagrangian information.
 - ⇒ e.g., Fueglistaler *et al* (2005), *JGR* characterise entry of dry air into stratosphere.

2. Balance in the Extratropics

Geostrophic balance

Horizontal components of momentum equation

(use planar approx. Valid if $L/a \ll 1$ where a =Earth's radius)

$$\frac{Dv}{Dt} + fu = -\frac{1}{\rho} \frac{\partial p}{\partial y} \quad \text{y-component}$$

If small Rossby number, $Ro=V/(fL)$, the last two terms dominate

\Rightarrow Geostrophic flow $u_g = -\frac{1}{f\rho} \frac{\partial p}{\partial y}$ e.g., zonally symmetric flow

Define geostrophic streamfunction

Geostrophic flow components are then

$$\psi_g = \frac{p'}{f_0 \rho_r}$$

$$u_g = -\frac{\partial \psi_g}{\partial y} \quad v_g = \frac{\partial \psi_g}{\partial x}$$

Hydrostatic balance

Consider vertical momentum equation:

$$\frac{Dw}{Dt} = -g - \frac{1}{\rho} \frac{\partial p}{\partial z}$$



Anelastic approximation. $\rho'/\rho \ll 1$ and $H_\theta \gg H_\rho$

$$\frac{Dw}{Dt} \approx \frac{g\theta'}{\theta_0} - \frac{\partial}{\partial z} \left(\frac{p'}{\rho_r} \right)$$



Hydrostatic approximation. $H/L \ll 1$

Buoyancy

$$b' = \frac{g\theta'}{\theta_0} \approx f_0 \frac{\partial \psi_g}{\partial z}$$

Together with geostrophic balance we obtain *thermal wind balance* which is fundamental in atmosphere and ocean.

$$\frac{\partial u_g}{\partial z} = -\frac{\partial^2 \psi_g}{\partial z \partial y} = -\frac{1}{f_0} \frac{\partial b'}{\partial y} \qquad \frac{\partial v_g}{\partial z} = \frac{\partial^2 \psi_g}{\partial z \partial x} = \frac{1}{f_0} \frac{\partial b'}{\partial x}$$

Predicting geostrophic flow evolution

Geostrophic and hydrostatic balance are *diagnostic*

- the time derivatives have been neglected.

Flow evolution depends on *ageostrophic flow*:

$$\begin{pmatrix} u_{ag} \\ v_{ag} \\ w_{ag} \end{pmatrix} = \begin{pmatrix} u - u_g \\ v - v_g \\ w \end{pmatrix}$$

e.g.,
$$\frac{Dv}{Dt} + (f - f_0)u + f_0 u_{ag} = 0$$

Quasi-geostrophic theory is obtained at next order and predicts vorticity evolution:

$$D_g (f_0 + \beta y + \xi_g) = f_0 \frac{1}{\rho_r} \frac{\partial(\rho_r w)}{\partial z} \longrightarrow$$

Vortex stretching increases absolute vorticity following geostrophic flow

and evolution of buoyancy:

$$D_g b' + N^2 w = 0 \longrightarrow$$

Advection of reference buoyancy downwards increases buoyancy following geostrophic flow

Define geostrophic material derivative

$$D_g = \frac{\partial}{\partial t} + u_g \frac{\partial}{\partial x} + v_g \frac{\partial}{\partial y}$$

QG potential vorticity

Vorticity and buoyancy evolution both depend on vertical motion, w .

Eliminating w from the two equations gives:

$$D_g q = 0$$

Meaning that **QG potential vorticity**, q , is *conserved* following the geostrophic flow, where

$$q = f_0 + \beta y + \frac{\partial^2 \psi_g}{\partial x^2} + \frac{\partial^2 \psi_g}{\partial y^2} + \frac{1}{\rho_r} \frac{\partial}{\partial z} \left(\rho_r \frac{f_0^2}{N^2} \frac{\partial \psi_g}{\partial z} \right)$$

Given distribution of q and boundary conditions, can *invert PV*

$$q' = q - f = L(\psi_g) \quad \text{to find} \quad \psi_g = L^{-1}(q')$$

Solution of QG system is to advect QGPV contours with the geostrophic flow (like a tracer) over one time-step. Then invert the new PV distribution to infer new flow and buoyancy:

$$u_g = -\frac{\partial \psi_g}{\partial y} \quad v_g = \frac{\partial \psi_g}{\partial x} \quad b' = f_0 \frac{\partial \psi_g}{\partial z}$$

Action-at-a-distance

Assuming density and N are constants and re-scaling the height coordinate so that $\hat{z} = (N / f_0)z$

$$q' \approx \left(\frac{\partial^2}{\partial x^2} + \frac{\partial^2}{\partial y^2} + \frac{\partial^2}{\partial \hat{z}^2} \right) \psi_g = \nabla^2 \psi_g$$

Poisson equation. Other examples from physics:

q' =point charge;

ψ =electric field potential

q' =force at a point on drum;

ψ =drum skin displacement

Means that a point **PV anomaly** *induces* flow far away.

The induced streamfunction is symmetrical about point in re-scaled coordinates.

$$\Rightarrow \text{natural aspect ratio} \quad \frac{L}{H} \approx \frac{N}{f_0} \approx 100$$

Inversion of a ball of uniform PV

Anomalies of q have both circulation and temperature anomalies, i.e. $\psi \propto -q'$

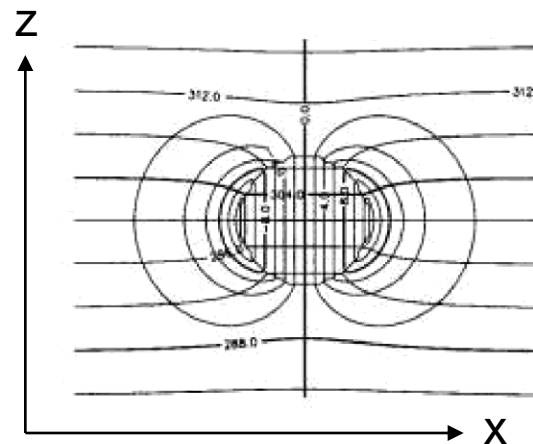
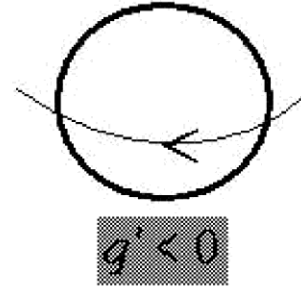
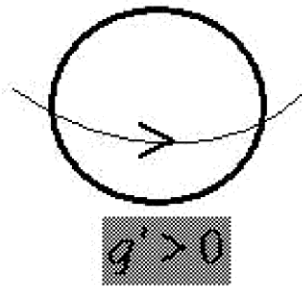

**θ, v for
positive PV
anomaly**

Rossby waves

Rossby waves propagate on horizontal PV gradients.

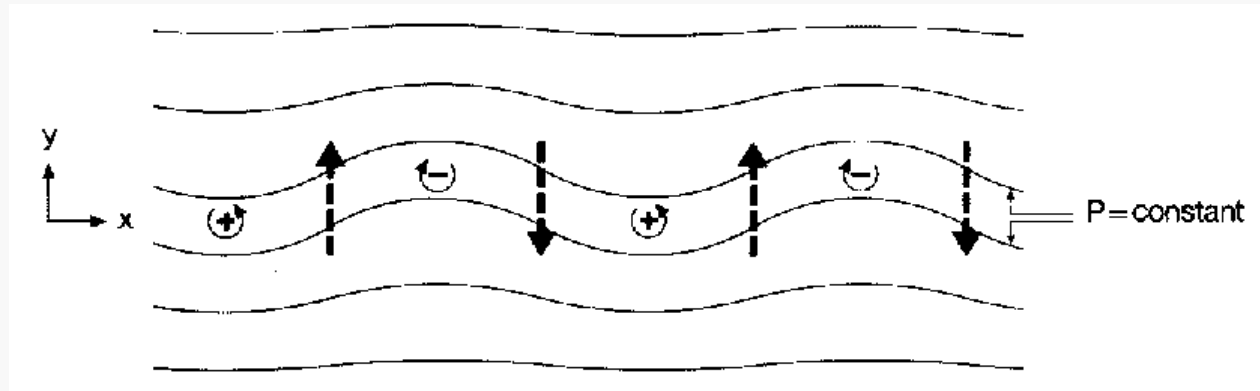

high PV
 $\bar{q}_y > 0$
 low PV

Air displaced to south carries high PV and forms +ve q'

$\Rightarrow q' > 0$ **induces** cyclonic circulation

\Rightarrow advects air southwards on western flank

\Rightarrow wave pattern propagates **westwards**

Phase speed:
$$c_p = \bar{u} - \frac{1}{k^2} \frac{\partial \bar{q}}{\partial y}$$

Fig: Hoskins, McIntyre and Robertson (1985), QJ

Baroclinic instability in terms of counter-propagating Rossby waves

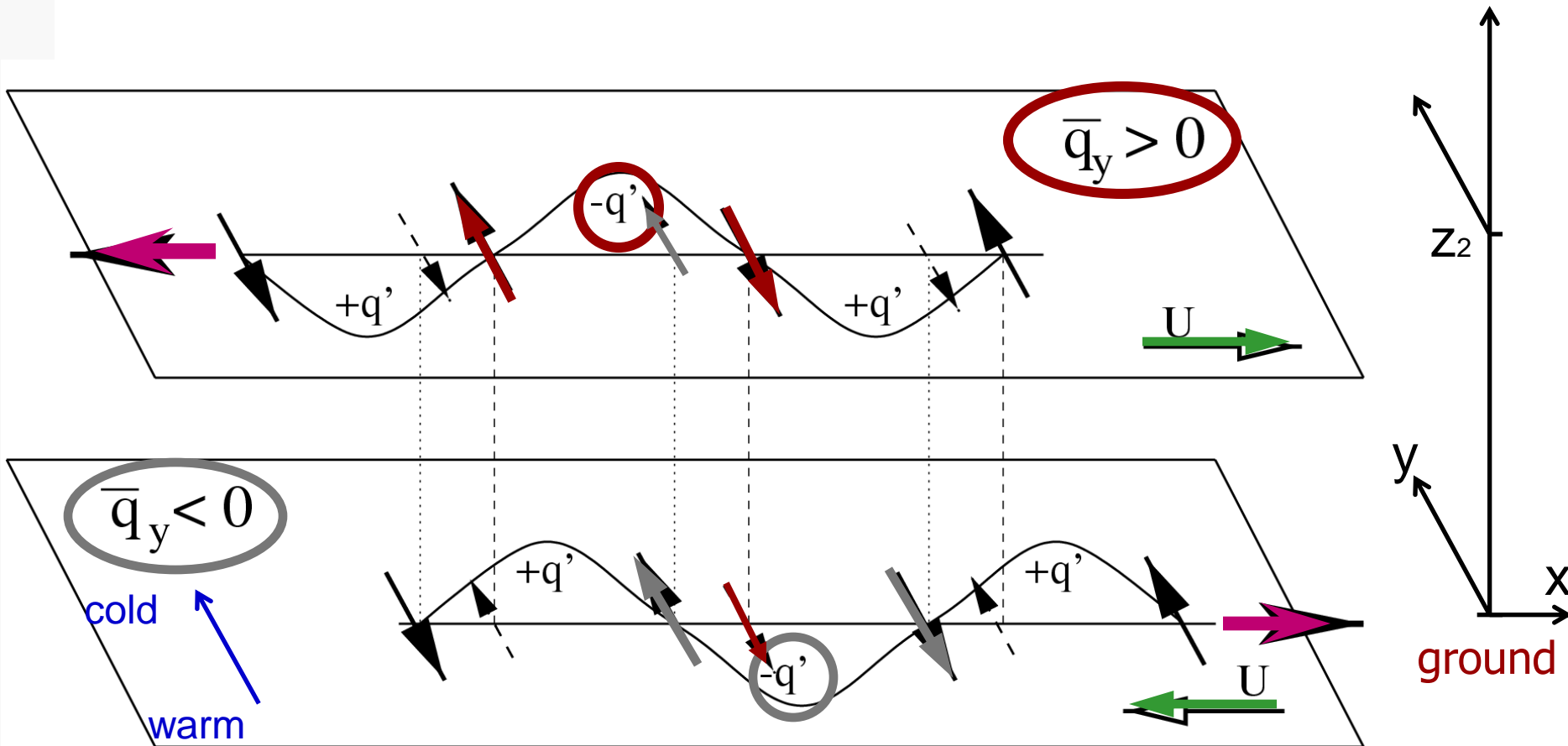

PV diagnostics

Ertel PV is conserved by the unapproximated dynamical equations following adiabatic, frictionless flow.

- Pragmatic approach is to calculate Ertel PV as diagnostic from model variables
 - ⇒ approximately follows motion of air along surfaces of constant potential temperature (isentropic surfaces)
 - ⇒ imagine the flow and stratification anomalies associated with PV anomalies and the way in which they would influence evolution
- More quantitatively make a balance approximation and invert the PV distribution or portions of it.

PV structure assuming conservation

RDF trajectories

PV (PVU) $T=-0.75$ days 300 hPa
Release on 12UT 20/10/2008

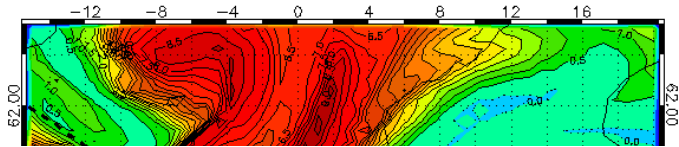

Pressure (hPa) $T=-1.75$ days 300 hPa
Release on 12UT 20/10/2008

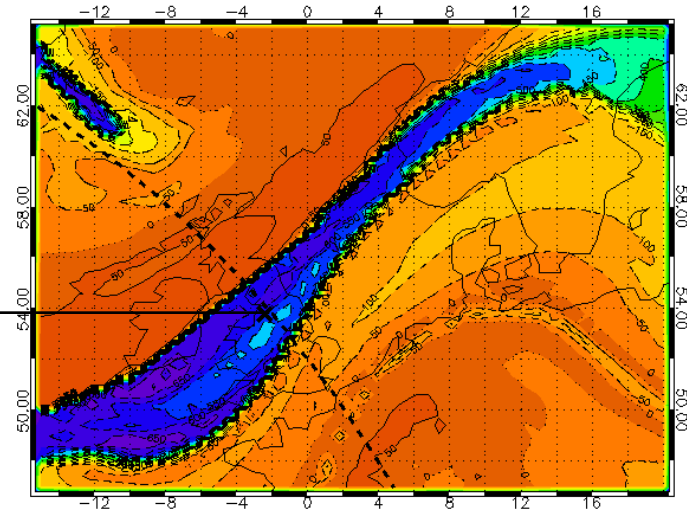

-2.4E 53.8N z=9.16km $T=-1.75$ days 12UT 20/10/2008

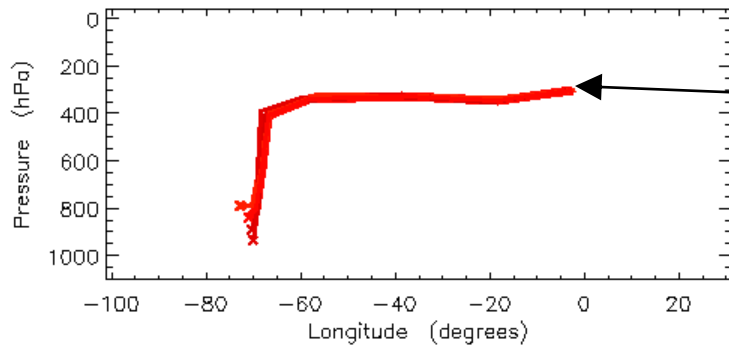
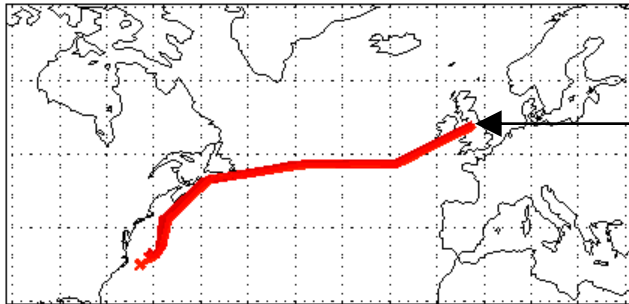

Pressure (hPa) $T=-1.75$ days 12UT 20/10/2008

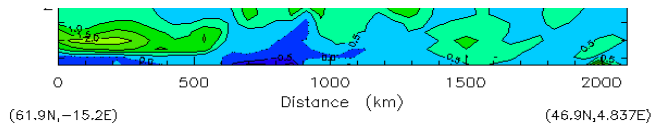
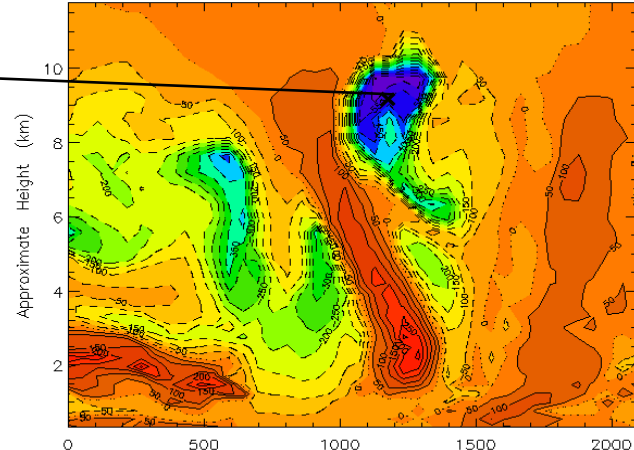

(61.9N, -15.2E) (46.9N, 4.837E)

Air mass: history of ascent

-2.4E 53.8N z=9.16km T=-1.75 days 12UT 20/10/2008

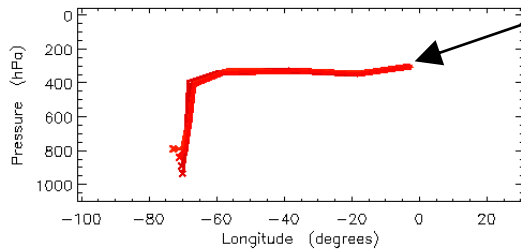
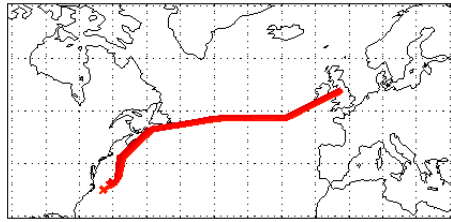

Pressure (hPa) T=-1.75 days 12UT 20/10/2008

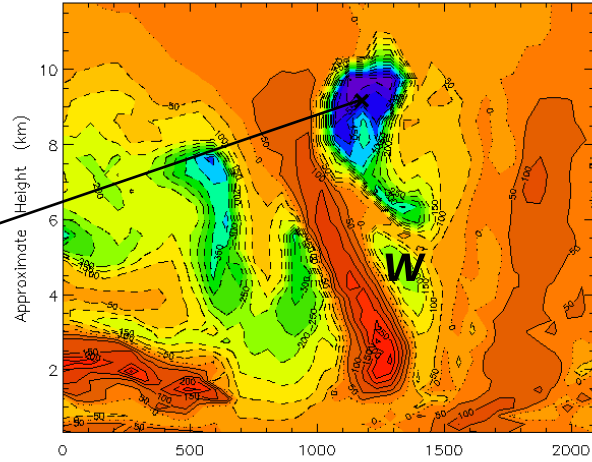

(61.9N,-15.2E) (46.9N,4.837E)

Change in pressure along trajectory before arrival over UK
Green/blue=ascent

1.75 days travel

-1.7E 53.0N z=5.21km T=-0.75 days 12UT 20/10/2008

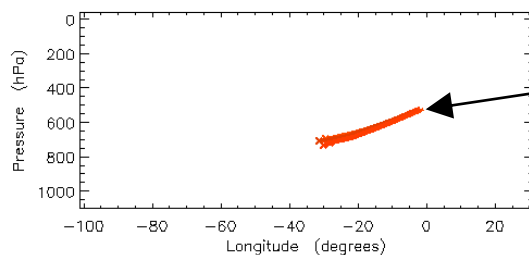
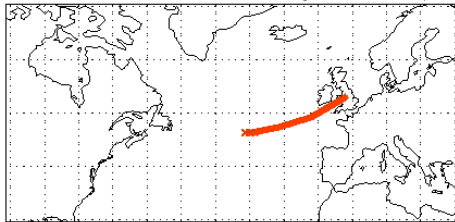

Pressure (hPa) T=-0.75 days 12UT 20/10/2008

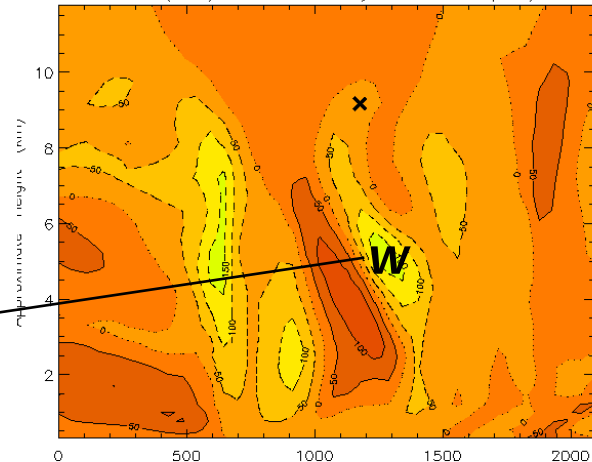

(61.9N,-15.2E) (46.9N,4.837E)

0.75 days travel

W = warm conveyor belt of cyclone over UK

Air mass: integrated heating

-2.4E 53.8N z=9.16km T=-1.75 days 12UT 20/10/2008

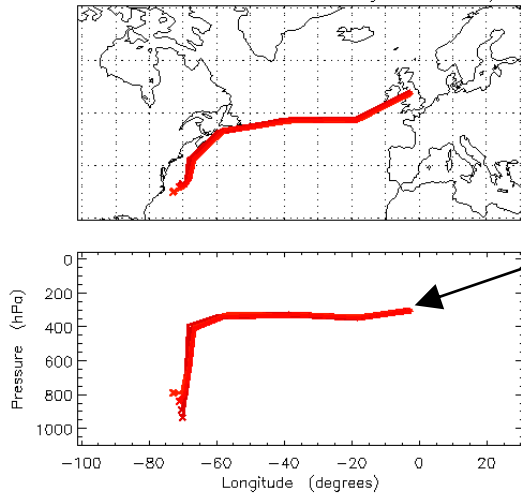

Theta (K) T=-1.75 days 12UT 20/10/2008

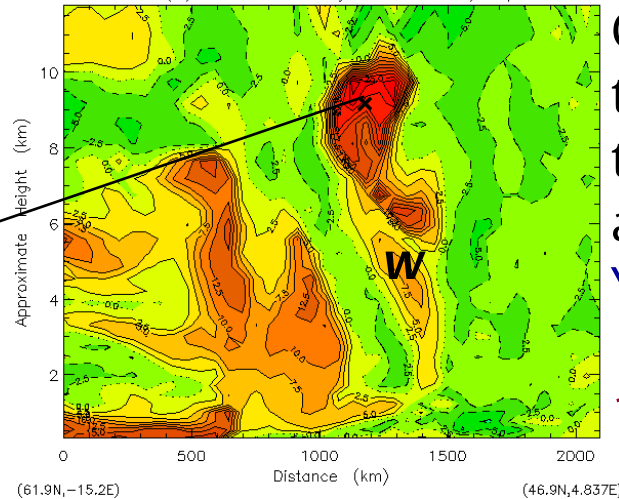

Change in potential temperature along trajectory before arrival over UK
Yellow/red=increase

1.75 days travel

-1.7E 53.0N z=5.21km T=-0.75 days 12UT 20/10/2008

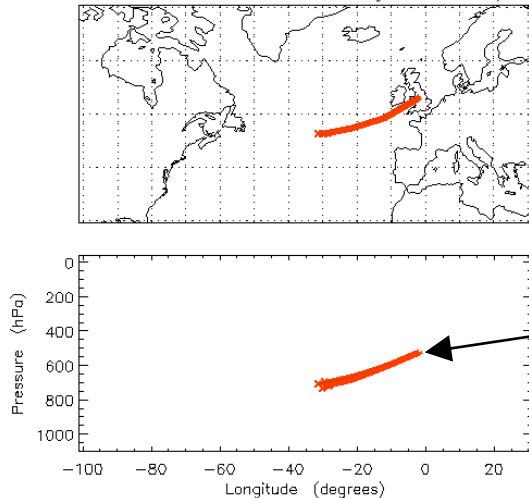

Theta (K) T=-0.75 days 12UT 20/10/2008

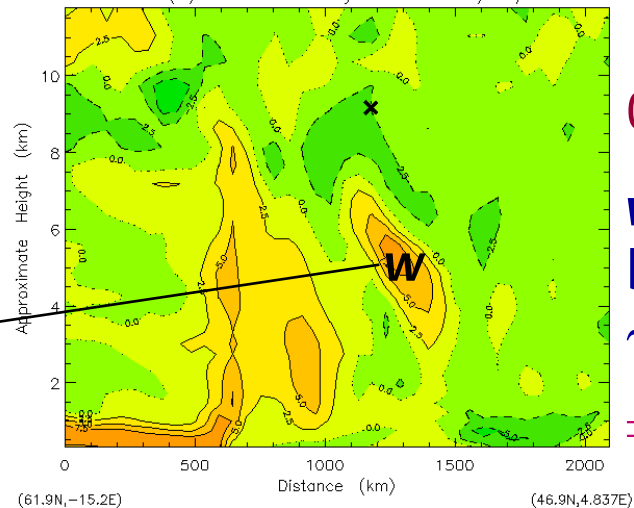

0.75 days travel

w = warm conveyor belt, latent heating rate $\sim 10 \text{ K day}^{-1}$

\Rightarrow PV non-conservation

Sensitivity of model PV to representation of diabatic processes

PV, 9.25 km elevation, 20/10/2008 1200 UTC

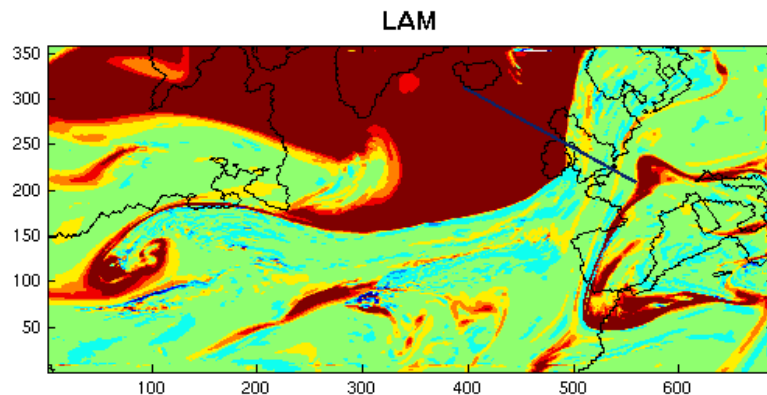
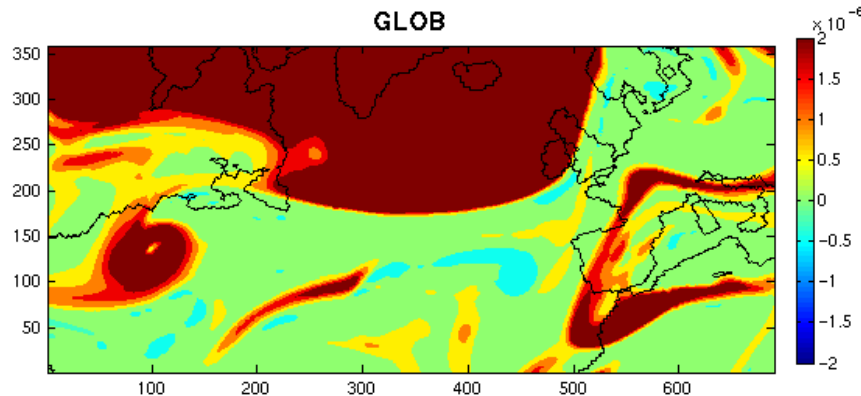

Experiments running the global and 12km LAM versions of the Met Office Unified Model

(Jeffrey Chagnon, NCAS-weather)

Same case as RDF example. Shown 4 days prior to forecast bust over Europe identified by Thomas Jung.

Same cross-section taken.

Global vs mesoscale model PV

PV, 6.2 km elevation, 20/10/2008 1200 UTC

GLOB

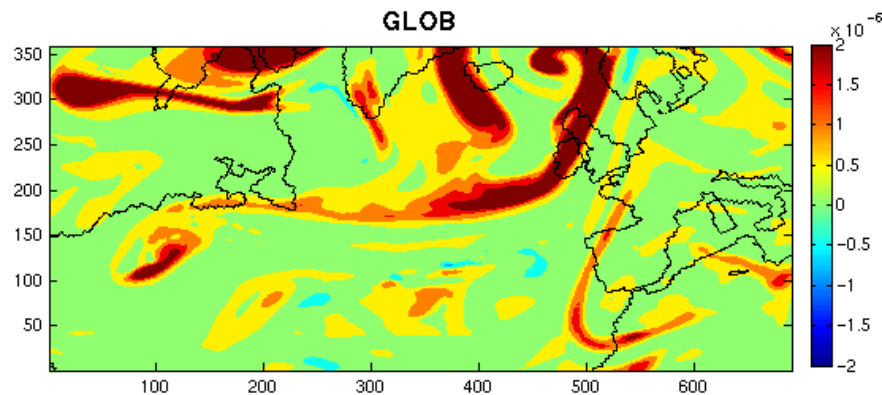

GLOBAL

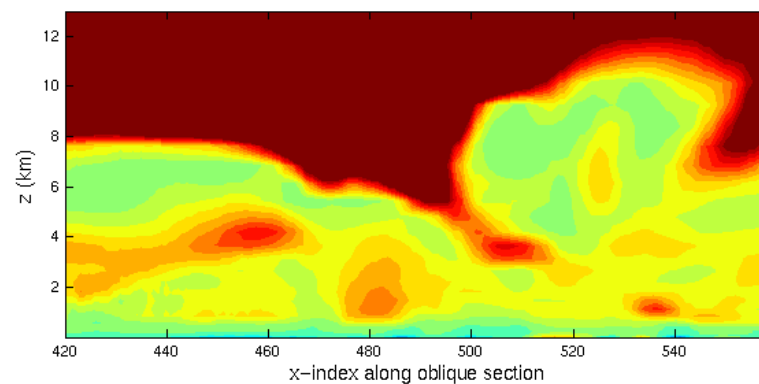

LAM

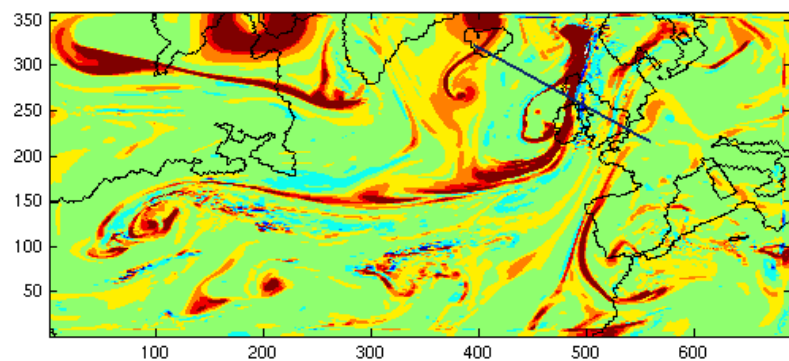

12km LAM

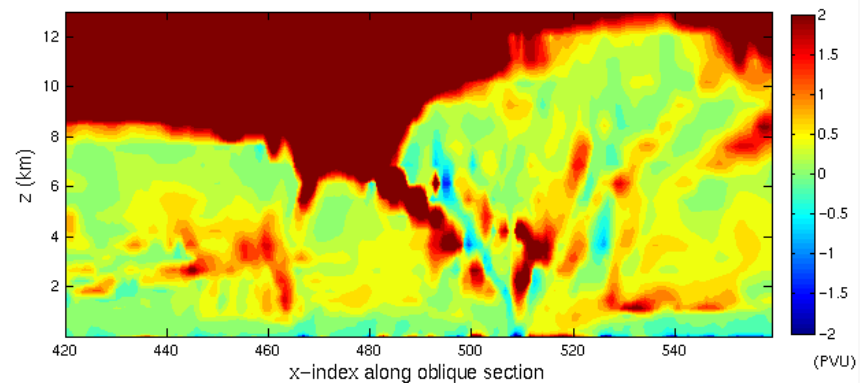

Tracking non-conservative changes in PV

- New set of diagnostics has been developed by Bob Plant (Reading) based on a Lagrangian decomposition of the PV field.
- Full PV conservation equation can be written:

$$\frac{Dq}{Dt} = \sum_p S_p \quad \text{where } S_p \text{ denotes the Lagrangian tendency resulting from one physical process in model}$$

- Tracers q_p are initialised as zero but experience only one of the S_p terms as well as being advected by the semi-Lagrangian scheme.
⇒ each tracer shows accumulated contribution of one process to PV.

$$q = q_{passive} + \sum_p q_p$$

Global vs mesoscale model PV

Accumulated PV tracers for the effects of convection and large-scale rain parameterisations in LAM model.

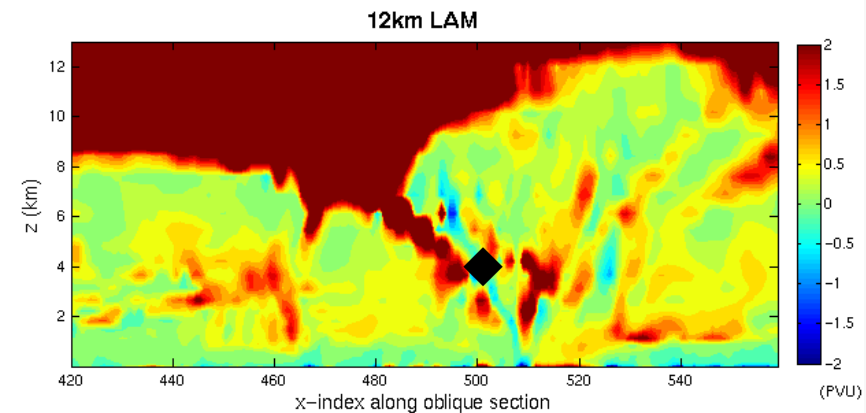
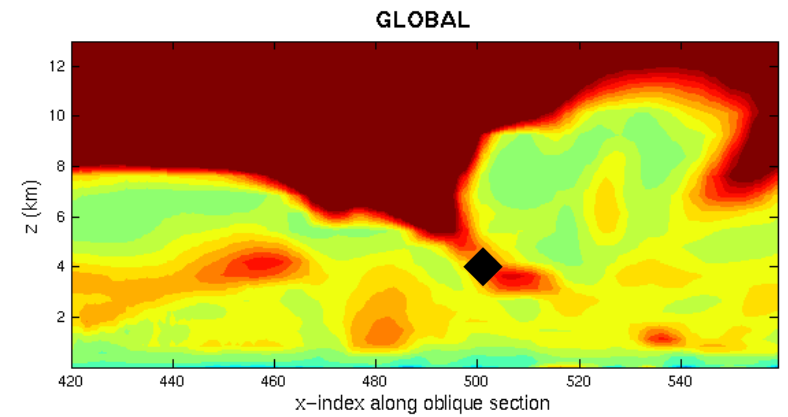
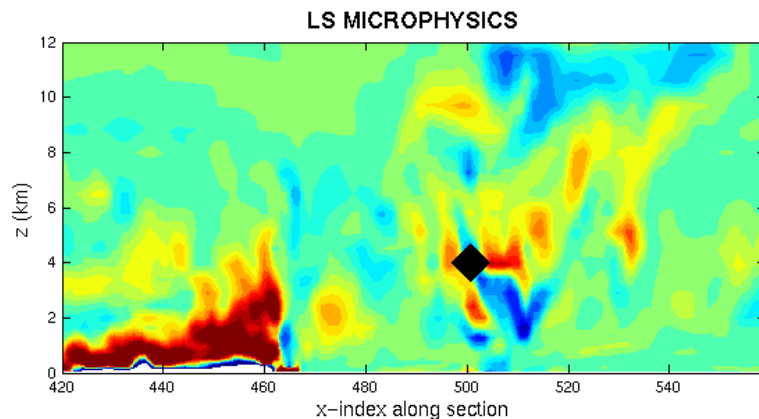
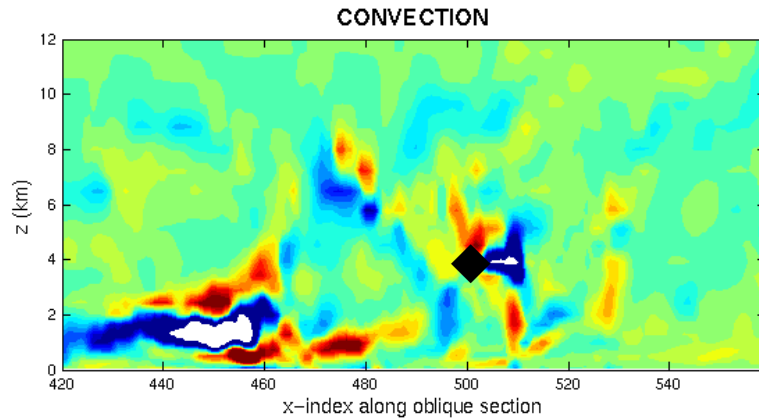

Typical forecast errors in upper-level PV field

PV error on 315 K
(forecast - analysis)

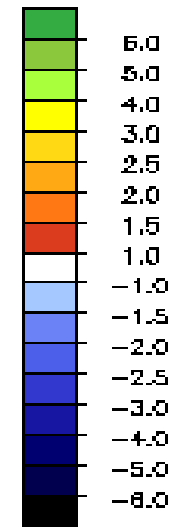
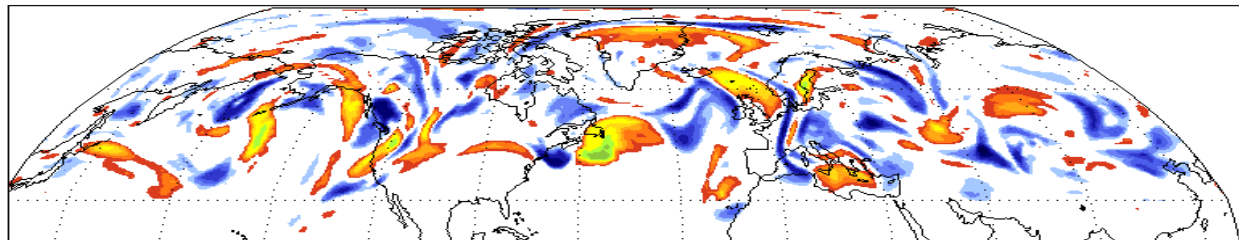

[pvu]

from Marco Didone and Huw Davies, ETH, Zurich

Typical forecast errors in upper-level PV field

PV error on 315 K
(forecast - analysis)

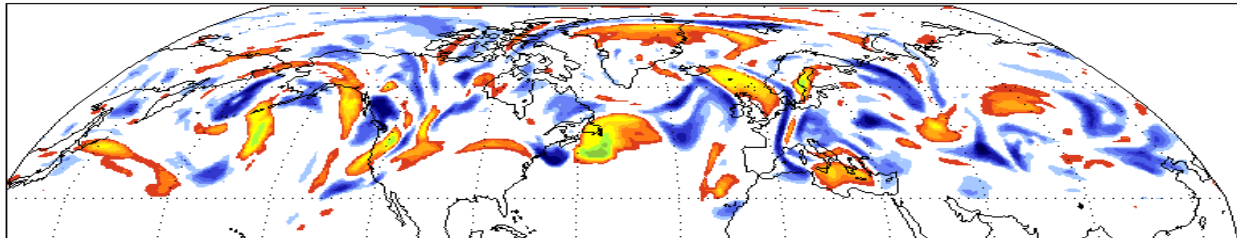

2-pvu tropopause
forecast, analysis

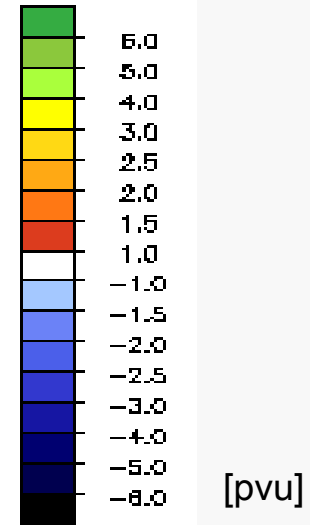
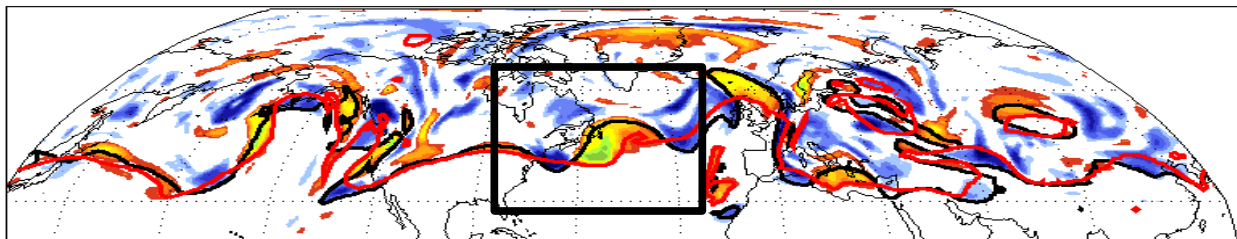
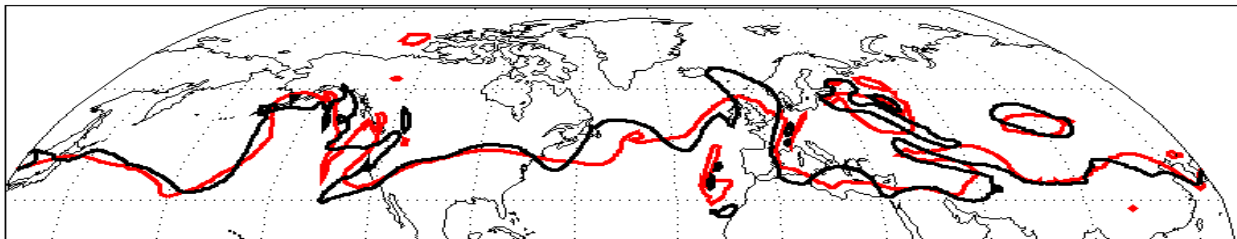

from Marco Didone and Huw Davies, ETH, Zurich

(c) Typical forecast errors in upper-level PV field

Lagrangian history (96 hour) from
positive & negative “PV error” regions

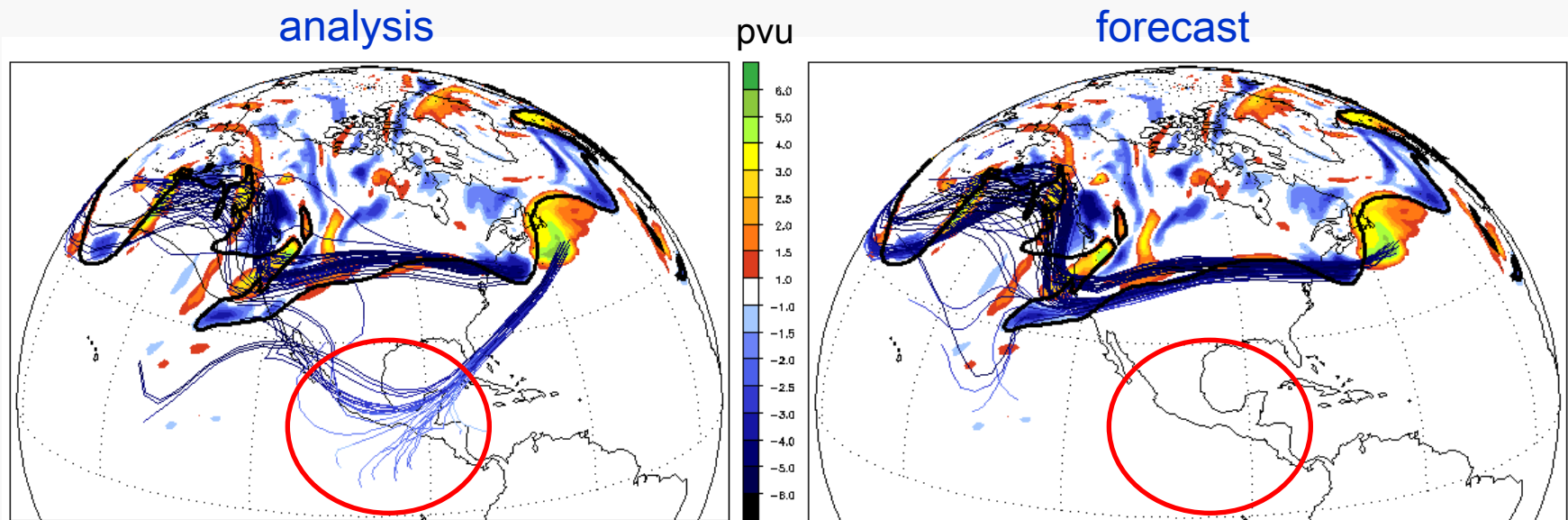

Q1: Are the -ve PV anomalies of tropopause level ridges systematically under-represented in forecasts?

Q2: Is this associated with a mis-representation of particular physical processes in the model (*attribution of model error by process*)?

T-NAWDEX

THORPEX- North Atlantic Waveguide and Downstream Impact Experiment

Has been proposed by the THORPEX working group **Predictability and Dynamical Processes** for the European THORPEX Science Plan.

Its overarching scientific goal is to investigate in detail the **physical processes that are primarily responsible for degradation in 1-7 day forecast skill** in global prediction systems and of their representation in NWP models.

An international field experiment is proposed for **autumn 2012** observing diabatic processes within Atlantic weather systems.

Piecewise PV inversion (PPVI)

- The PV diagnostics discussed so far relate only to the material conservation property of PV.
- If one believes that a localised PV anomaly has been misrepresented, it would be desirable to find the consequent impact.
- PPVI involves isolating a PV anomaly and inverting it to obtain associated flow and temperature anomalies (assuming an appropriate form of balance).
- These diagnostically related anomalies are then subtracted from the full fields, and the modified state is integrated to find new forecast.

Davis and Emanuel (1991), *MWR*

Hakim, Keyser and Bosart (1996), *MWR*

PPVI example: composite of events leading to a cut-off low in Eastern Atlantic

Peter Knippertz (Leeds), Luise Frohlich and Florian Maier (Mainz)

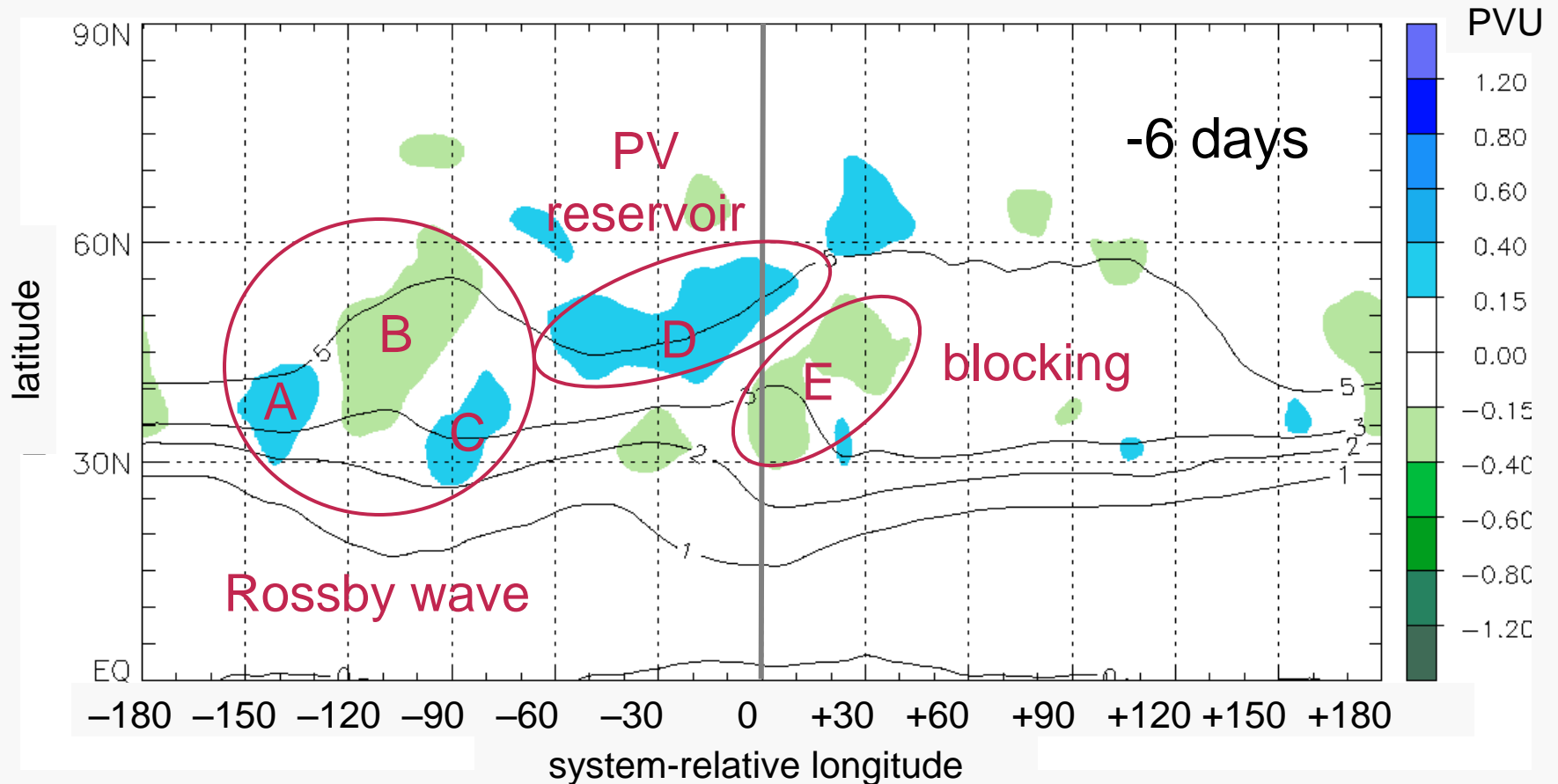

COMPOSITE STUDY

System-relative composite of PV anomalies in 400–100 hPa
North Atlantic, winter half year (Oct.–Mar.), 87 systems

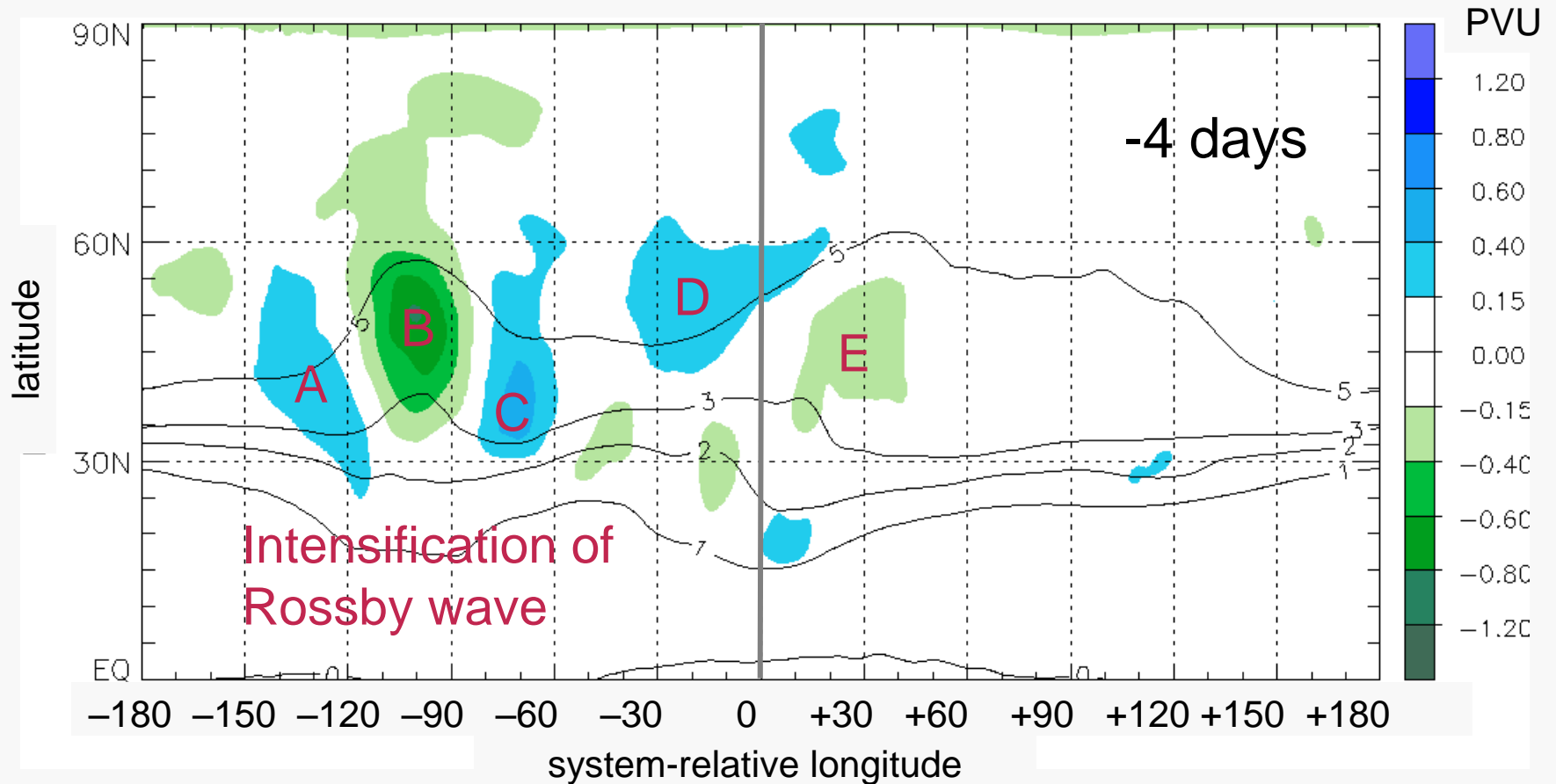

COMPOSITE STUDY

System-relative composite of PV anomalies in 400–100 hPa
North Atlantic, winter half year (Oct.–Mar.), 87 systems

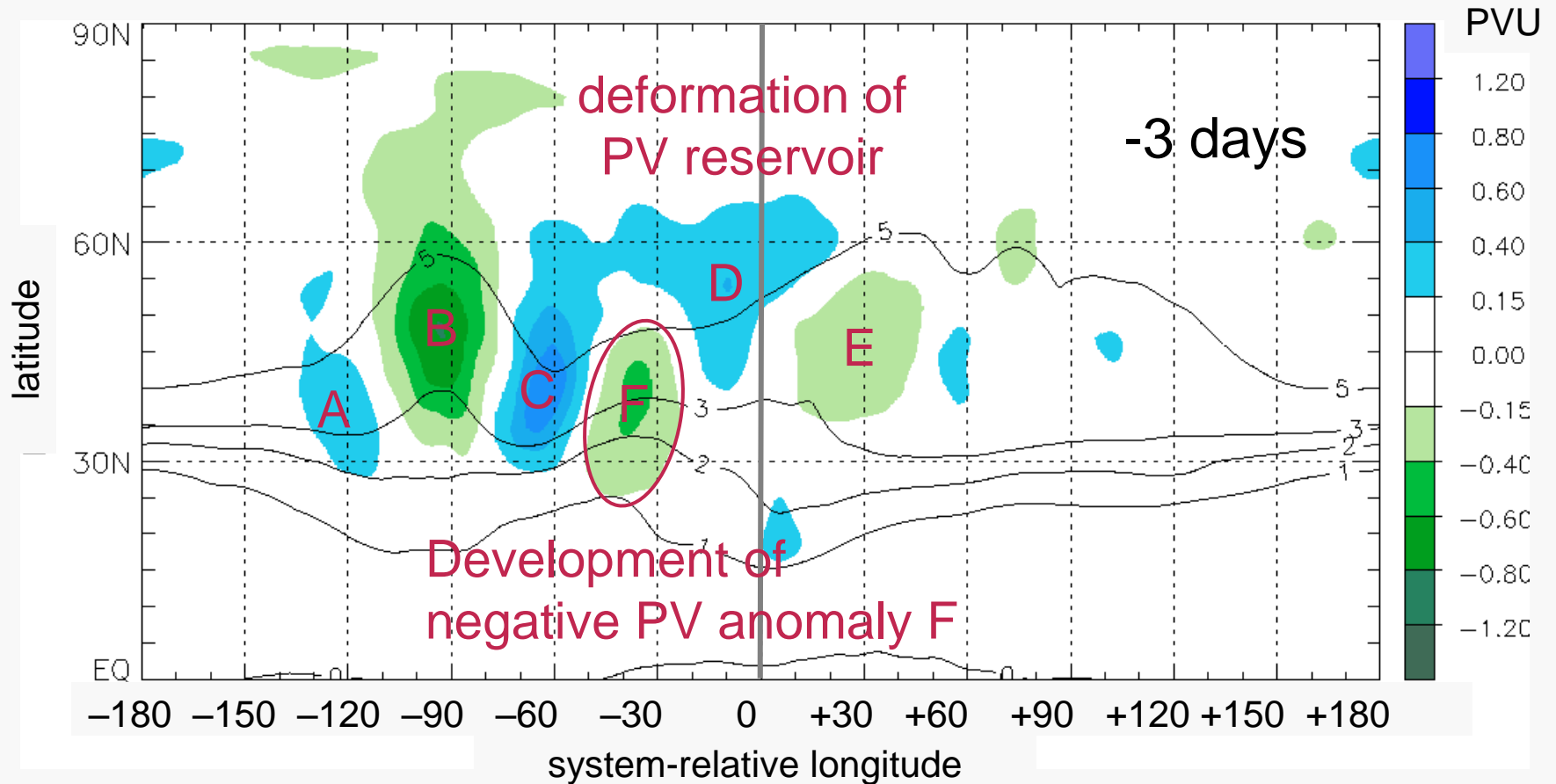

COMPOSITE STUDY

System-relative composite of PV anomalies in 400–100 hPa
North Atlantic, winter half year (Oct.–Mar.), 87 systems

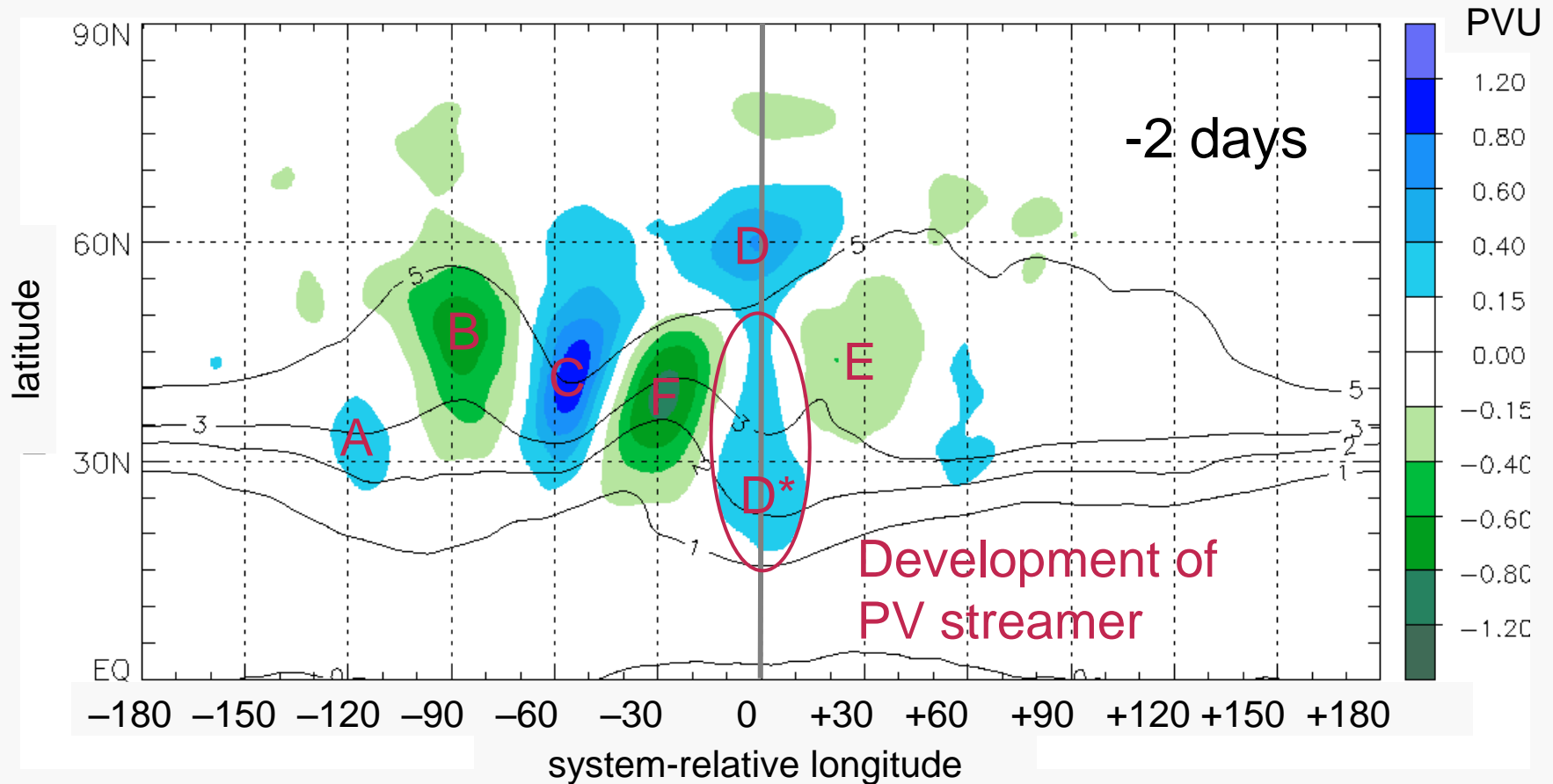

COMPOSITE STUDY

System-relative composite of PV anomalies in 400–100 hPa
North Atlantic, winter half year (Oct.–Mar.), 87 systems

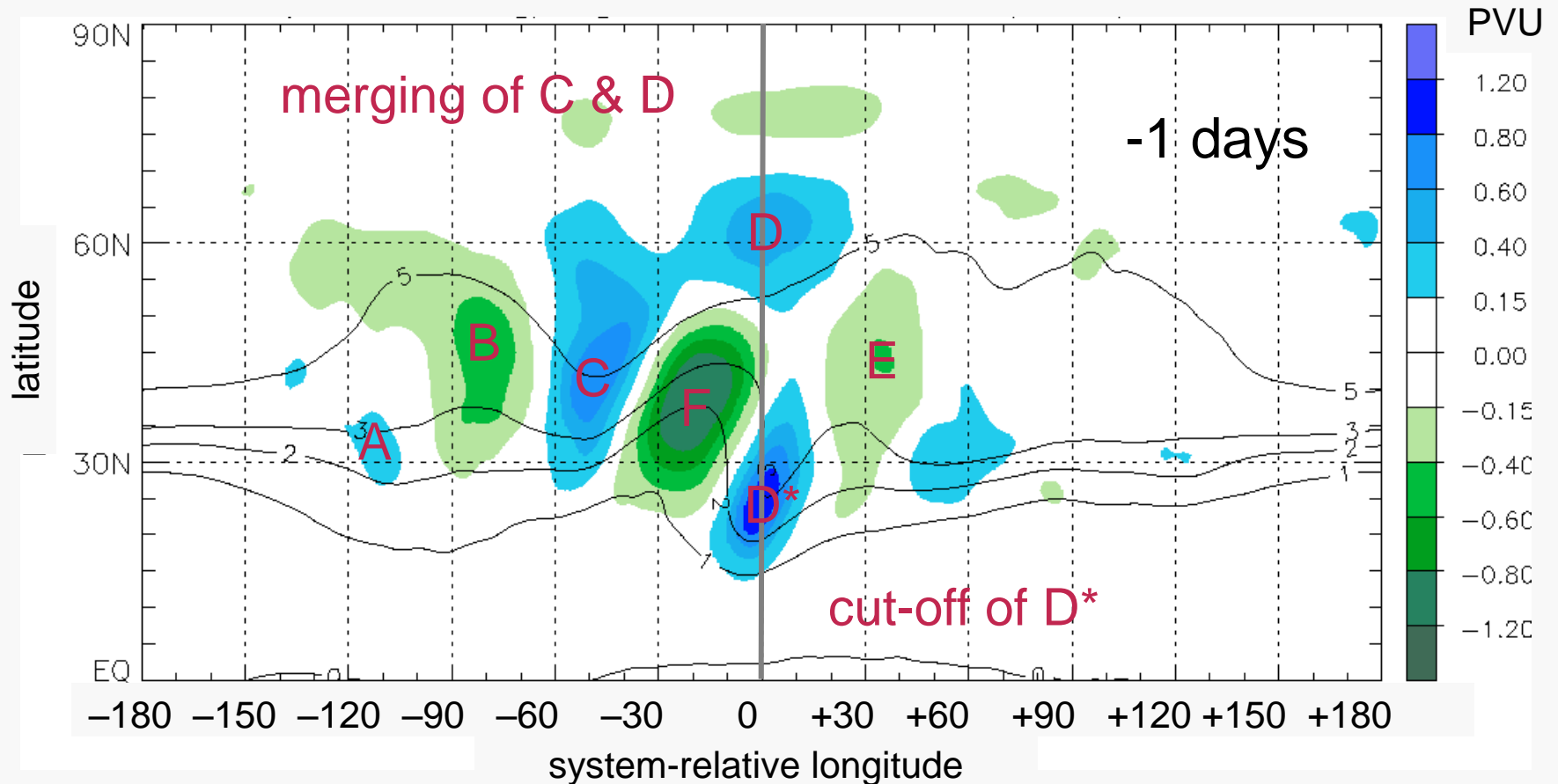

COMPOSITE STUDY

System-relative composite of PV anomalies in 400–100 hPa
North Atlantic, winter half year (Oct.–Mar.), 87 systems

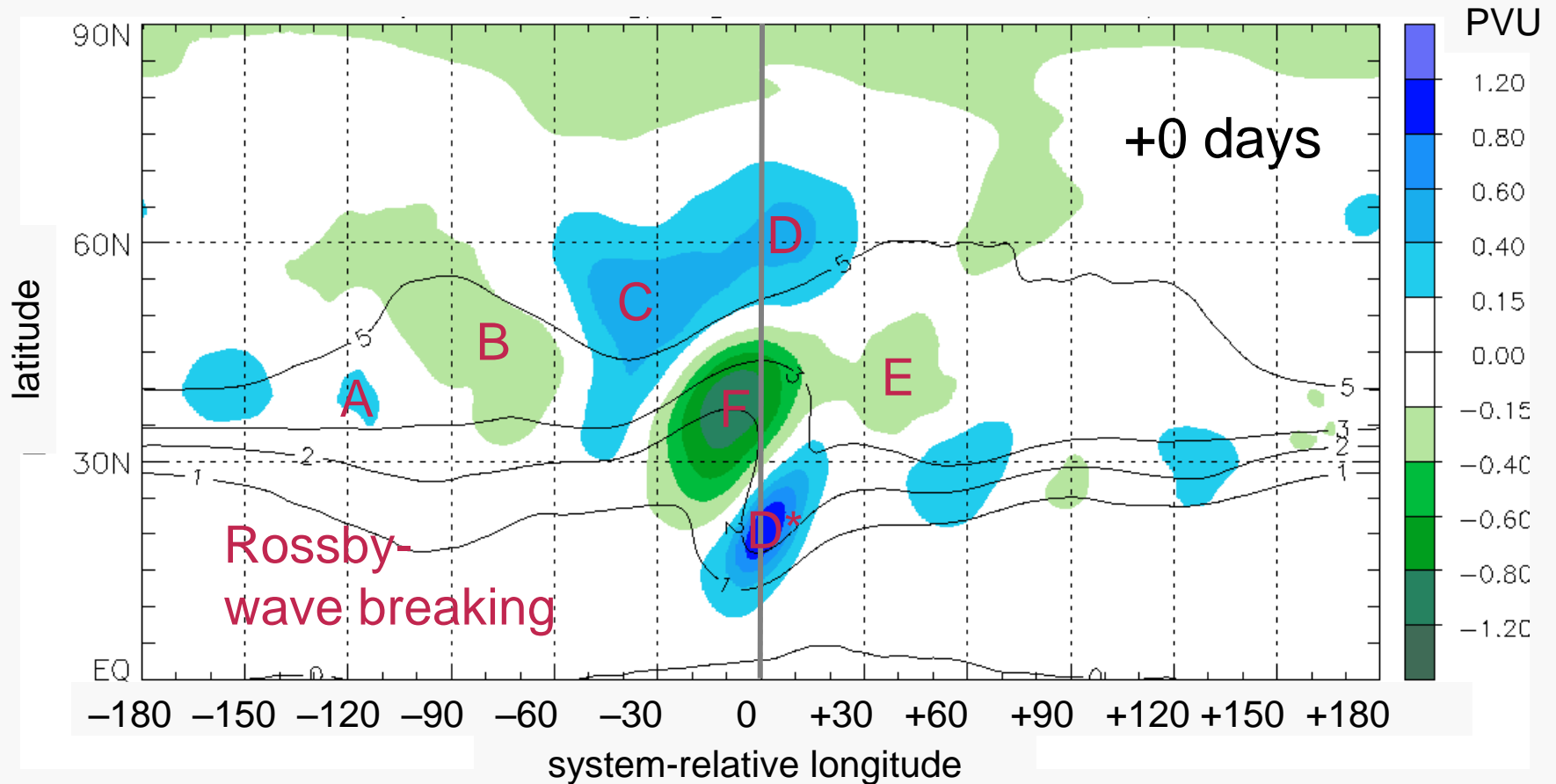

PPVI SENSITIVITY EXPERIMENTS

Control simulation

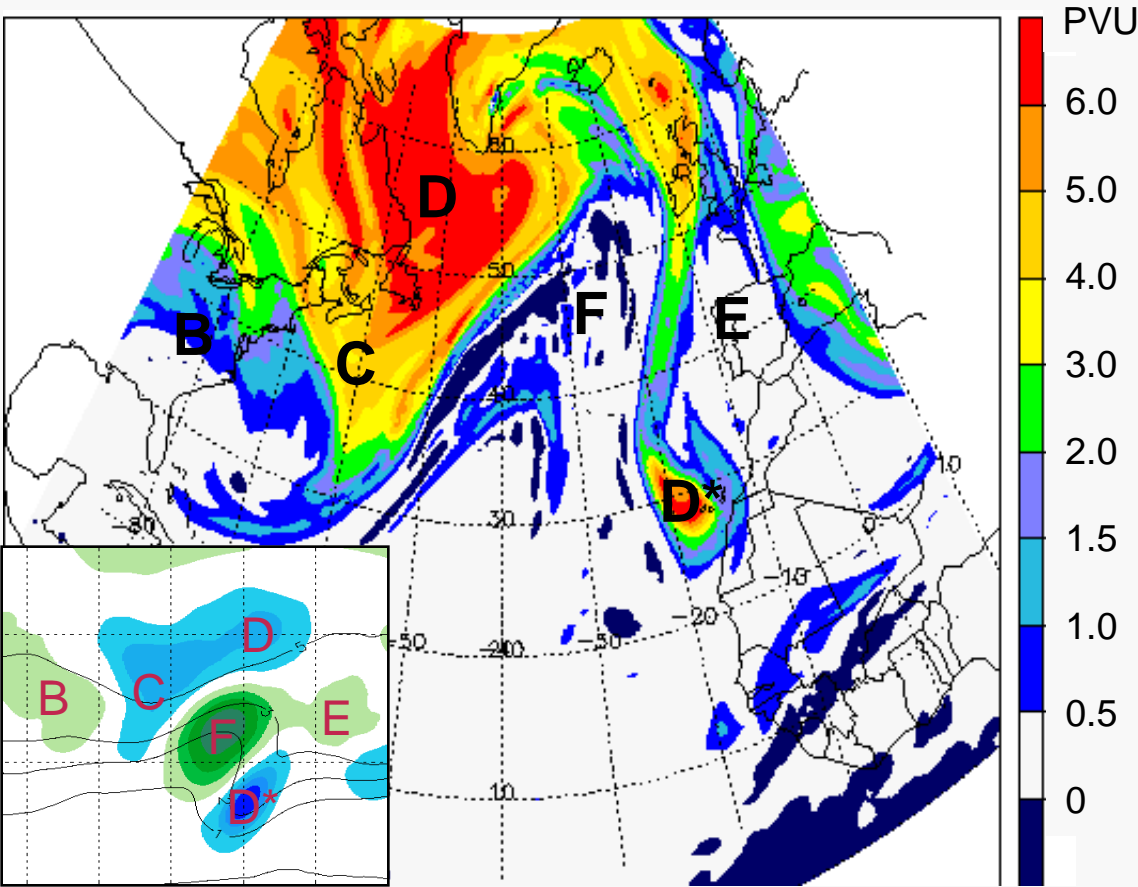

Global model
(GME) of the
German Weather
Service (DWD)

PV at 320 K
1200 UTC
05 January 2002
(+36h)

PPVI SENSITIVITY EXPERIMENTS

Control simulation

Modified initial conditions C

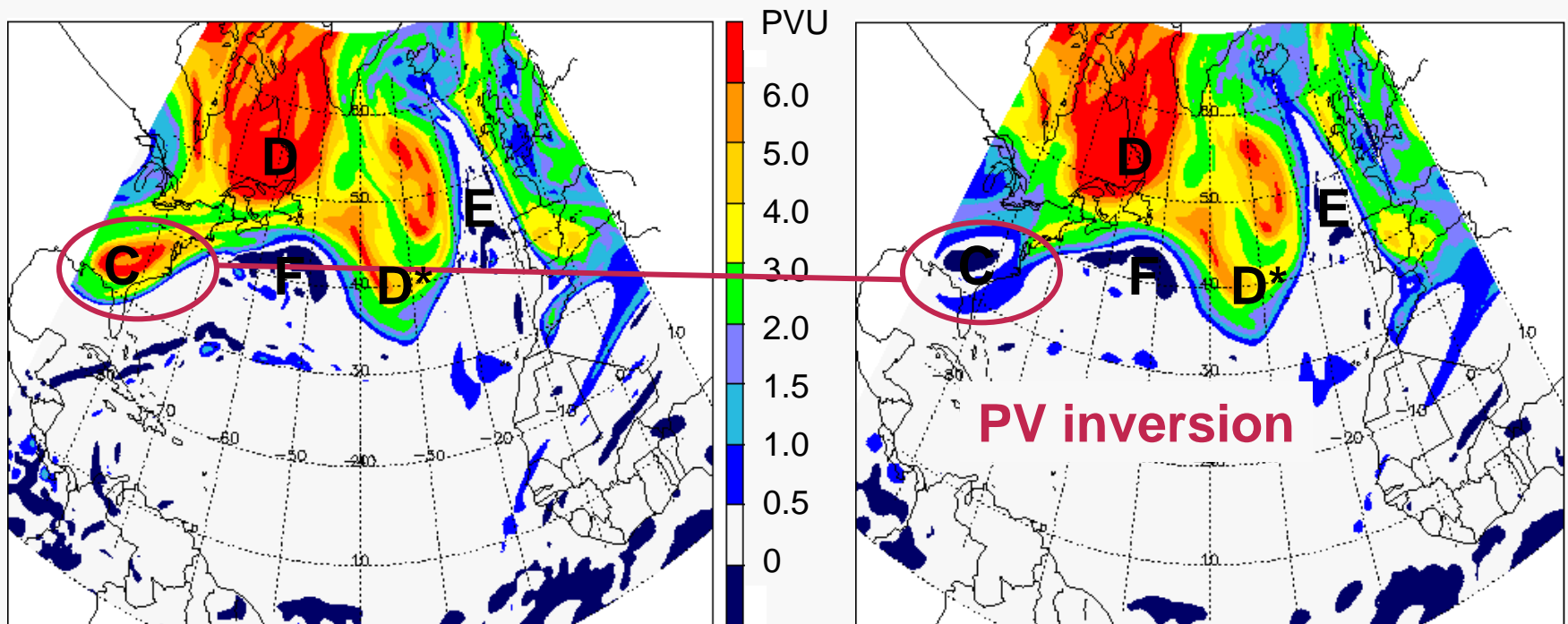

PV at 320 K at 0000 UTC 04 January 2002 (+00h)

PPVI SENSITIVITY EXPERIMENTS

Control simulation

Modified initial conditions C

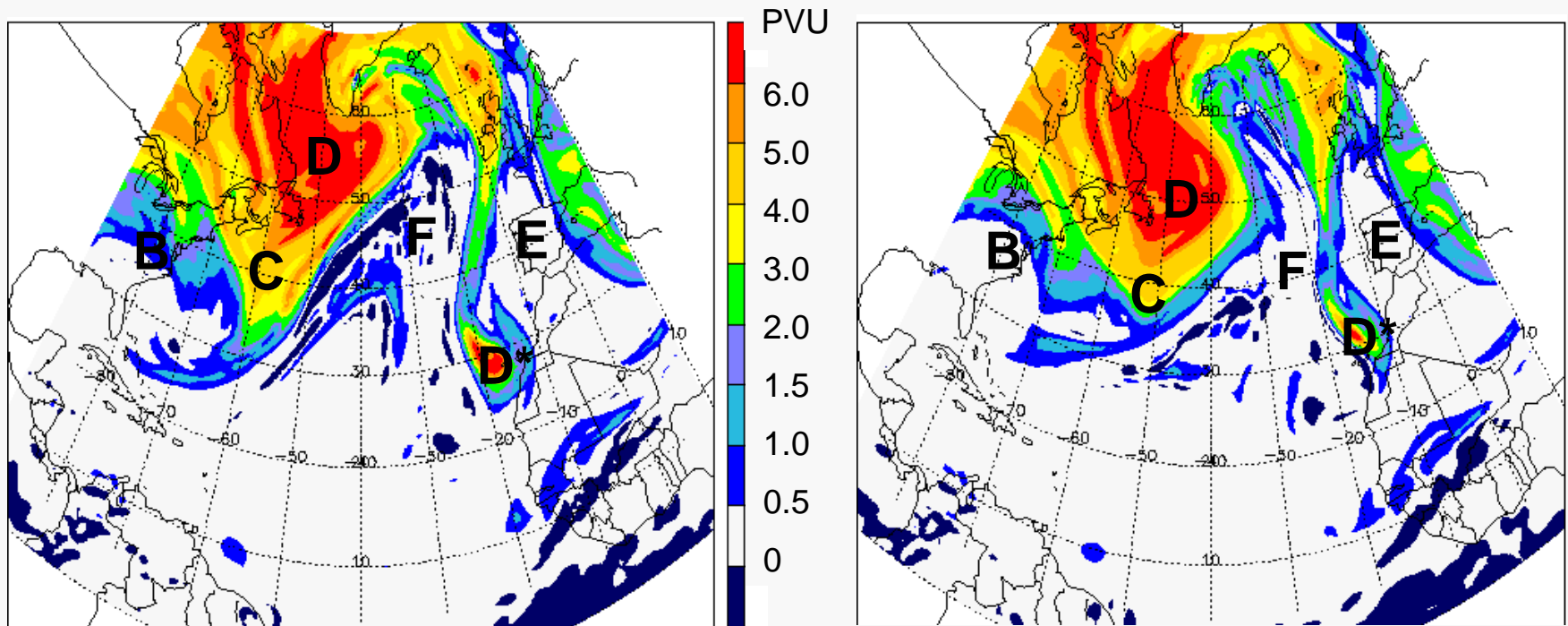

PV at 320 K at 1200 UTC 05 January 2002 (+36h)

PPVI SENSITIVITY EXPERIMENTS

Control simulation

Modified initial conditions E

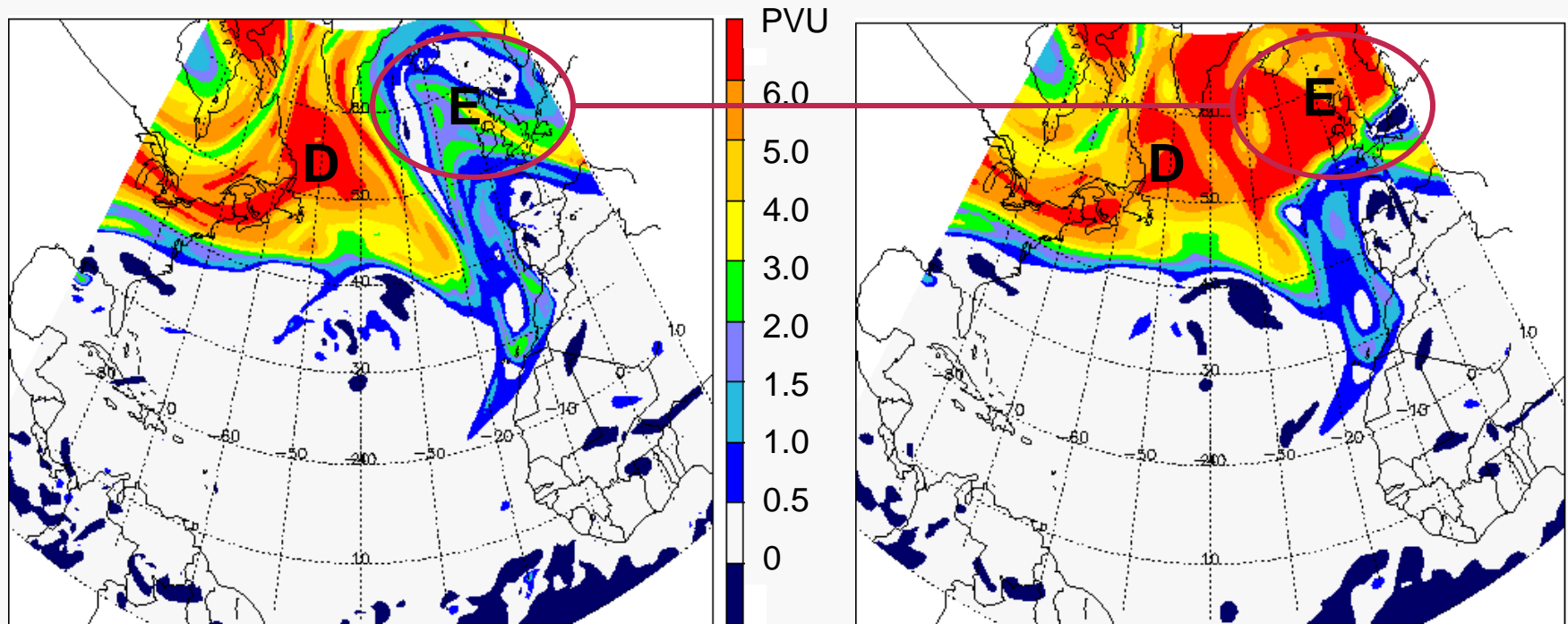

PV at 320 K at 0000 UTC 02 January 2002 (+00h)

PPVI SENSITIVITY EXPERIMENTS

Control simulation

Modified initial conditions E

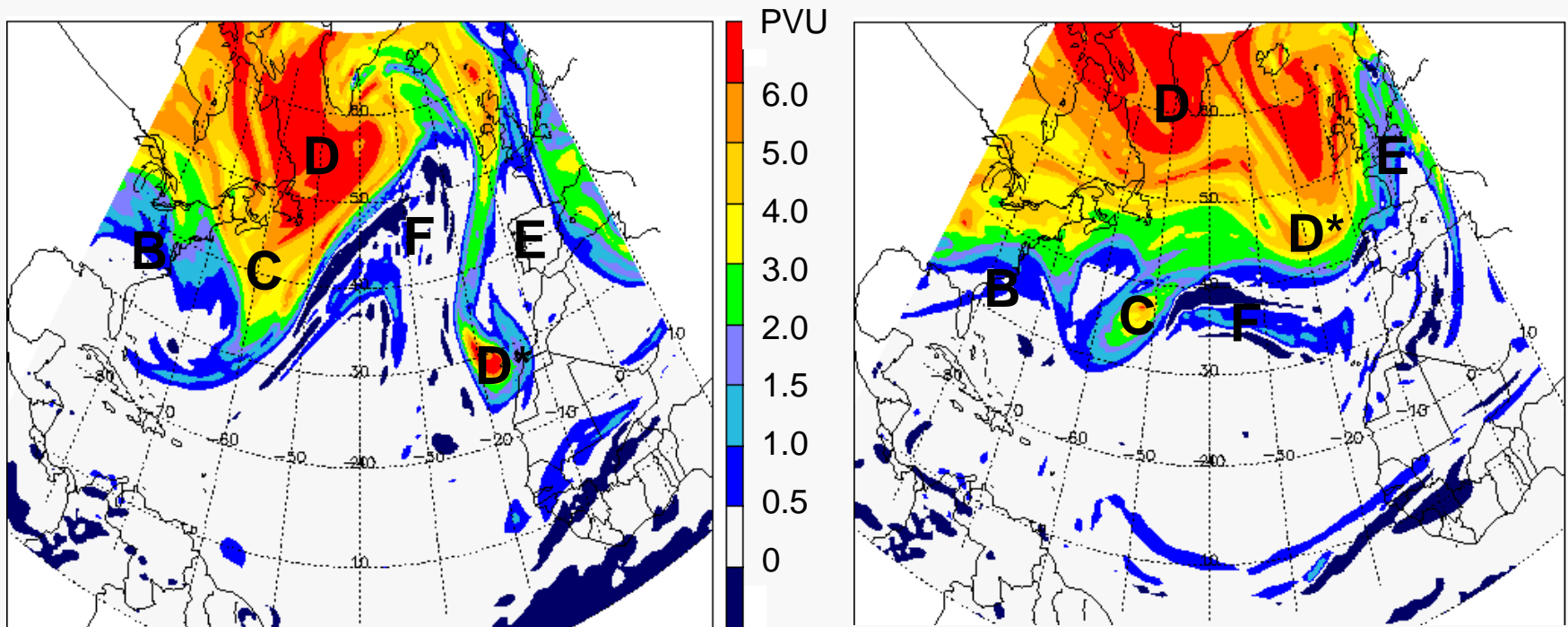

PV at 320 K at 1200 UTC 05 January 2002 (+84h)

PROCESS SENSITIVITY EXPERIMENT

Control simulation

No latent heating

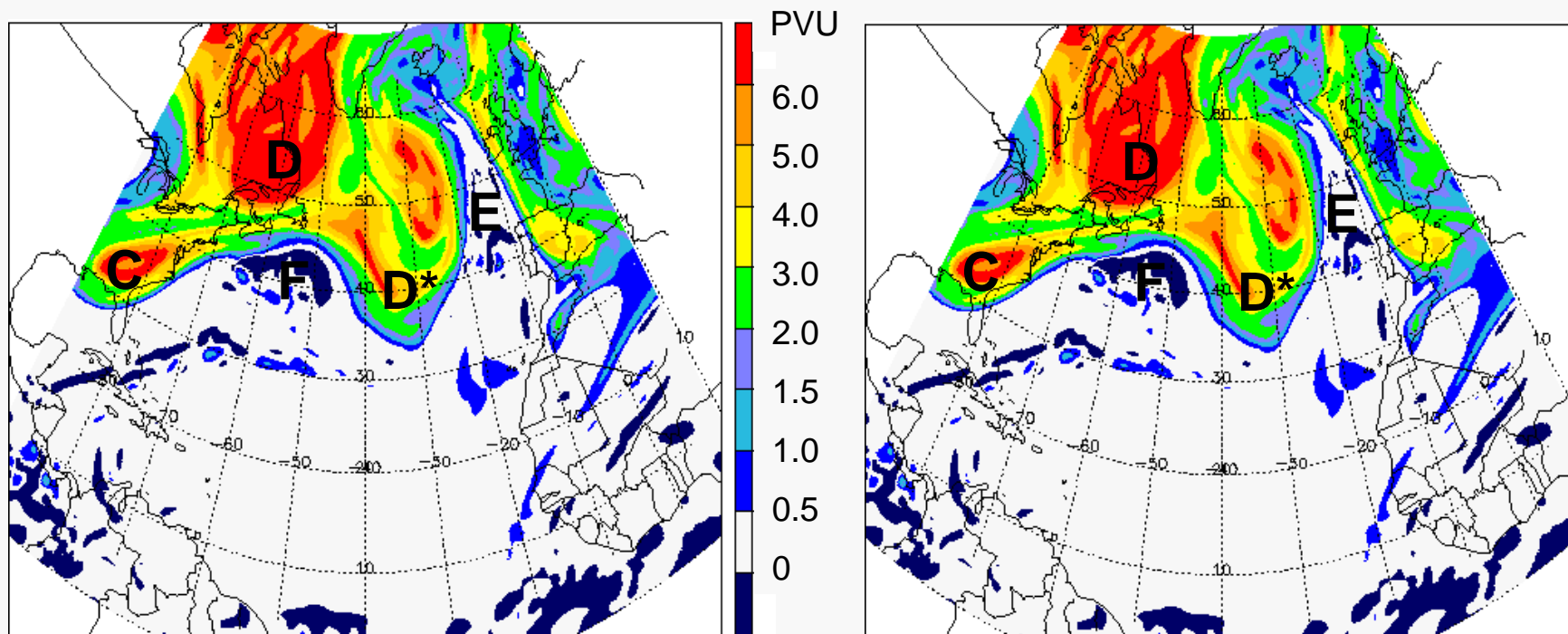

PV at 320 K at 0000 UTC 04 January 2002 (+00h)

PROCESS SENSITIVITY EXPERIMENT

Control simulation

No latent heating

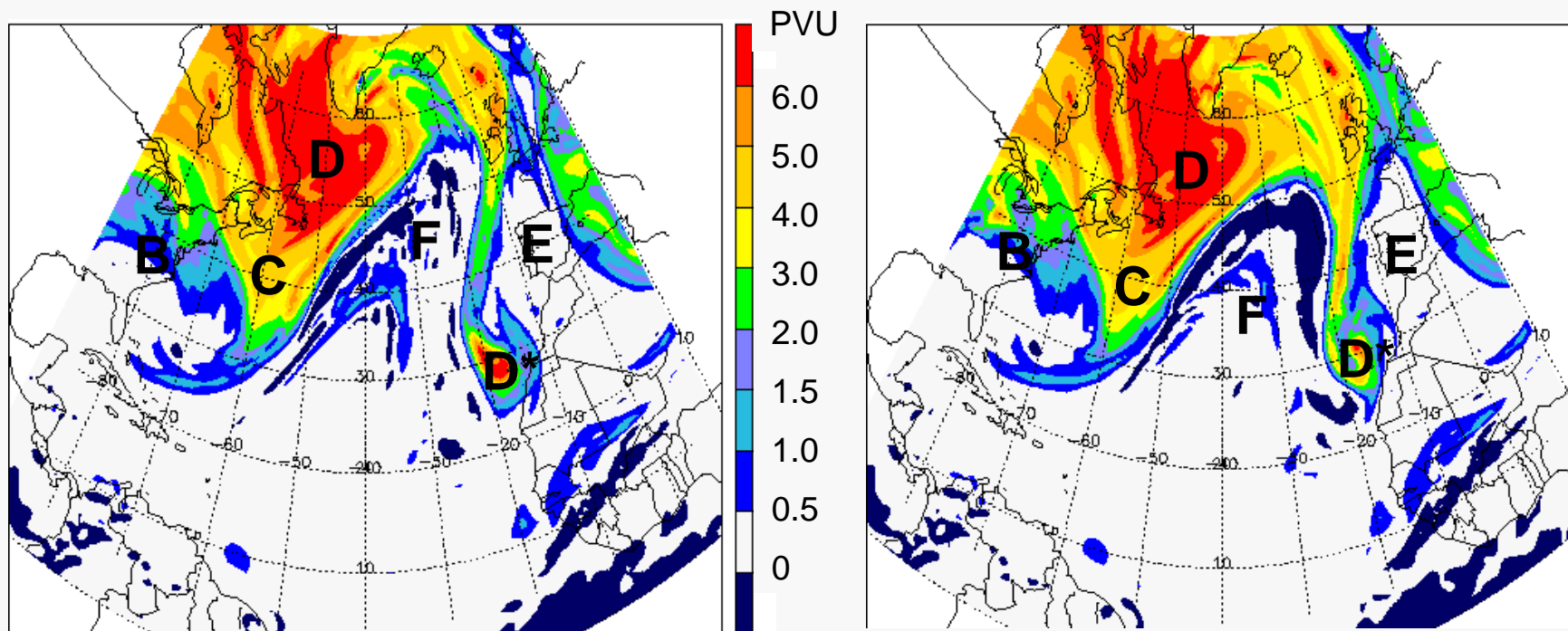

PV at 320 K at 1200 UTC 05 January 2002 (+36h)

SUMMARY OF PPVI STUDY

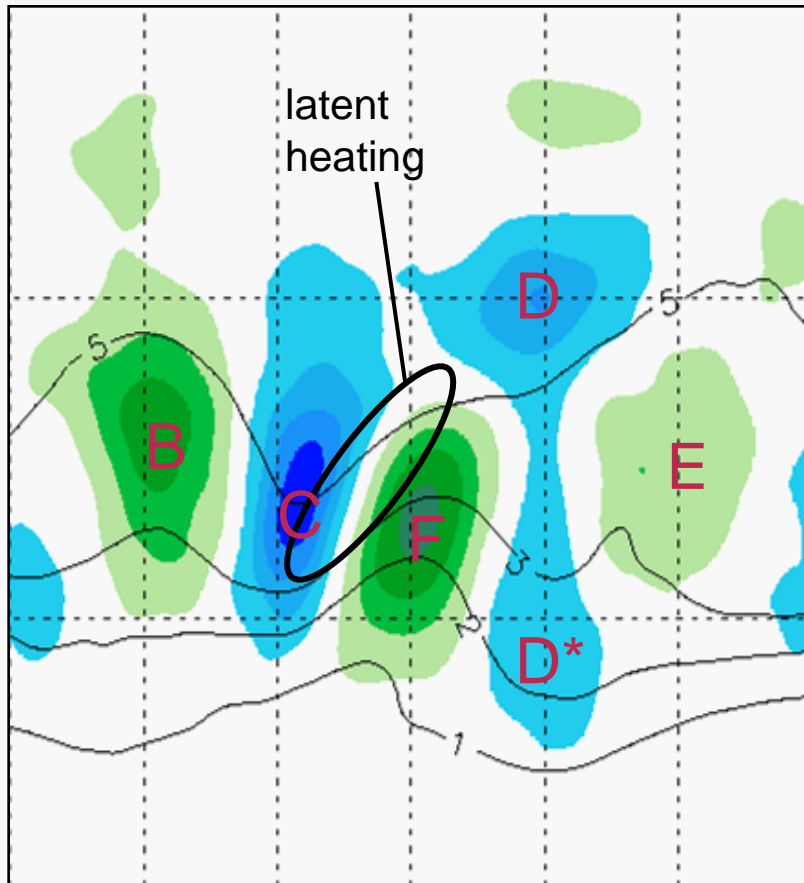

- Most important prerequisite for formation of D^* is **dipole D & E**.
- Rossby wave (B&C) & **latent heating** are of secondary importance.
- Further tests and different case studies will show how **robust** this result is.
- Existence of stable precursors up to 6 days ahead suggests some degree of **predictability**.

2. Balanced flow diagnostics

- Diagnose PV from primitive equation model, rather than integrate an explicitly balanced model.
- PV evolution is dominated by advection along isentropic surfaces.
- Finescale PV structure can be reconstructed using RDF trajectories.
- Integrated effects of non-conservative processes in a model can be diagnosed using PV tracers \Rightarrow reveals differences between models.
- Piecewise PV inversion can be a useful tool
 - However, sense behind spatially isolating a PV anomaly is debatable when part of a wave rather than cut-off vortex.
 - Egger (2008), *JAS*; Methven and de Vries (2008), *JAS*
 - Revising forecasts by PV modification on the basis of water vapour channel satellite imagery gives mixed results in forecast skill.
 - Demirtas and Thorpe (1999), *MWR*; Swarbrick (2001), *Met. Apps.*

3. Mean flow and eddies

Theories describing the evolution of disturbances, including waves and vortices, include a “basic state” upon which the disturbance evolves.

However, the atmosphere is complex with large-amplitude time-varying disturbances. The “background state” must be identified with some form of average. Candidates are:

1. Time average (at fixed points)

Cannot evolve!

The averaged state is not a solution on its own, and “interactions” with waves contrive to make it steady.

⇒ *e.g., local emissions could dominate the averaged state.*

2. Zonal average (Eulerian)

Adiabatic eddy fluxes

⇒ *Zonal average fluctuates as rapidly as the waves.*

(Eulerian) Zonal Average

Consider thermodynamic equation

$$\frac{\partial(\rho\theta)}{\partial t} + \nabla \cdot (\rho\theta\mathbf{u}) = \rho\mathcal{H} + \nabla \cdot \mathbf{F}$$

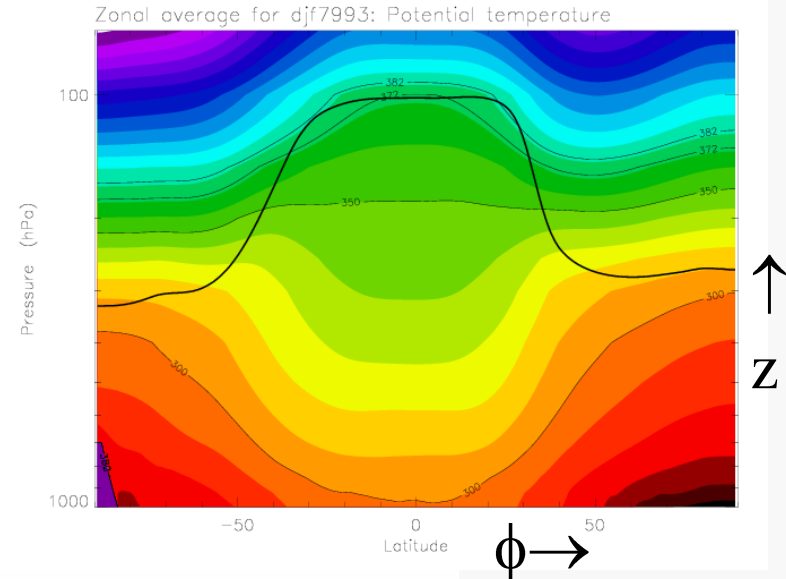

Partitioning variables into zonal average and eddy terms: $\theta = [\theta] + \theta^*$

etc. and $\rho = \rho_0 \Rightarrow$

$$\frac{\partial[\theta]}{\partial t} + \nabla \cdot ([\theta][\mathbf{u}]) = [\mathcal{H}] + \nabla \cdot [\mathbf{F}] - \nabla \cdot ([\theta^*\mathbf{u}^*])$$

PROBLEMS

(A) The “eddy flux divergence” is not small \Rightarrow to predict evolution of $[\theta]$, need to simultaneously predict θ^* evolution.

(B) $\nabla \cdot ([\theta^*\mathbf{u}^*])$ varies on eddy advection timescales \Rightarrow so does $\frac{\partial[\theta]}{\partial t} \Rightarrow$ zonal average is not slowly varying.

Space and Time Filtering

Can the background be extracted by a spatial or temporal filter?

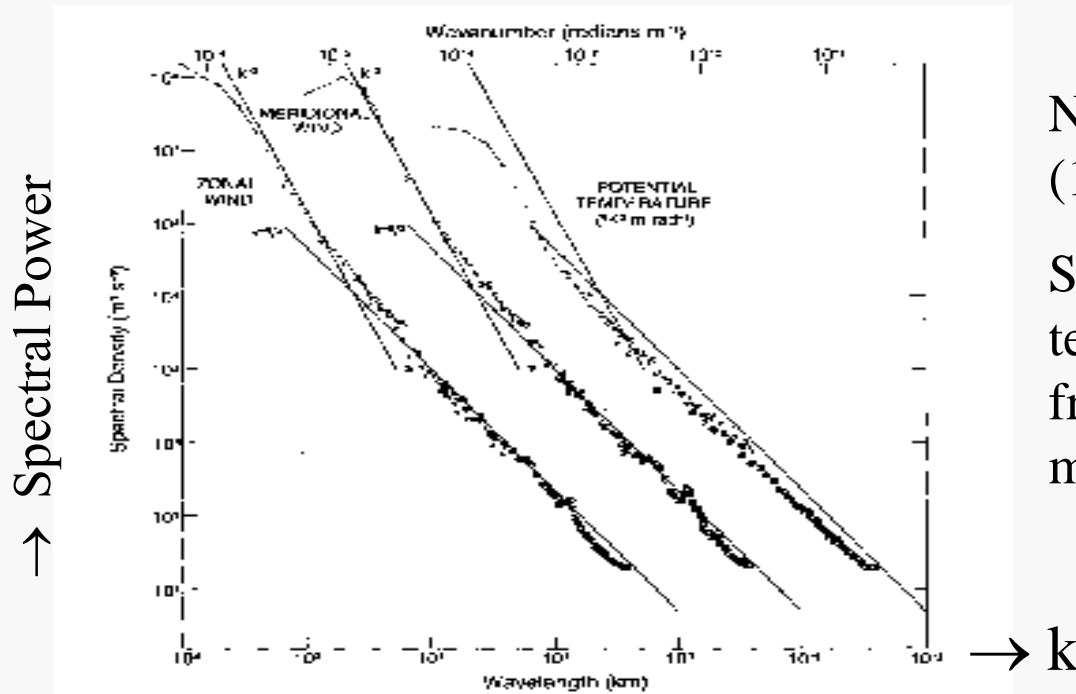

Nastrom and Gage
(1985), JAS, 42, 950.

Scaling of wind and
temperature covariance
from regular aircraft
measurements (GASP).

BUT, no spectral gap. More similar to a power law \Rightarrow scale invariance.

Wave-background partition depends on filter \Rightarrow “scale interaction” is artificial.

By itself the filtered state is **not** a solution to the primitive equations.

An alternative in tracer relative coordinates

Example of a 2D tracer field

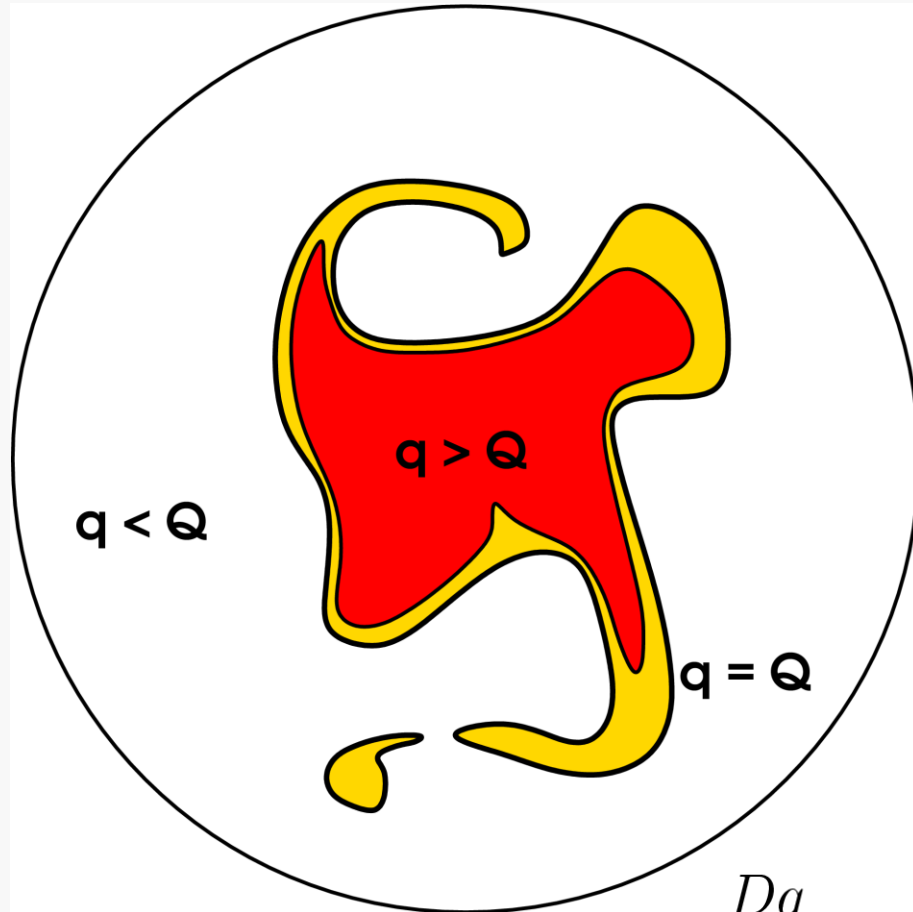

$$\frac{Dq}{Dt} = S$$

Its background state

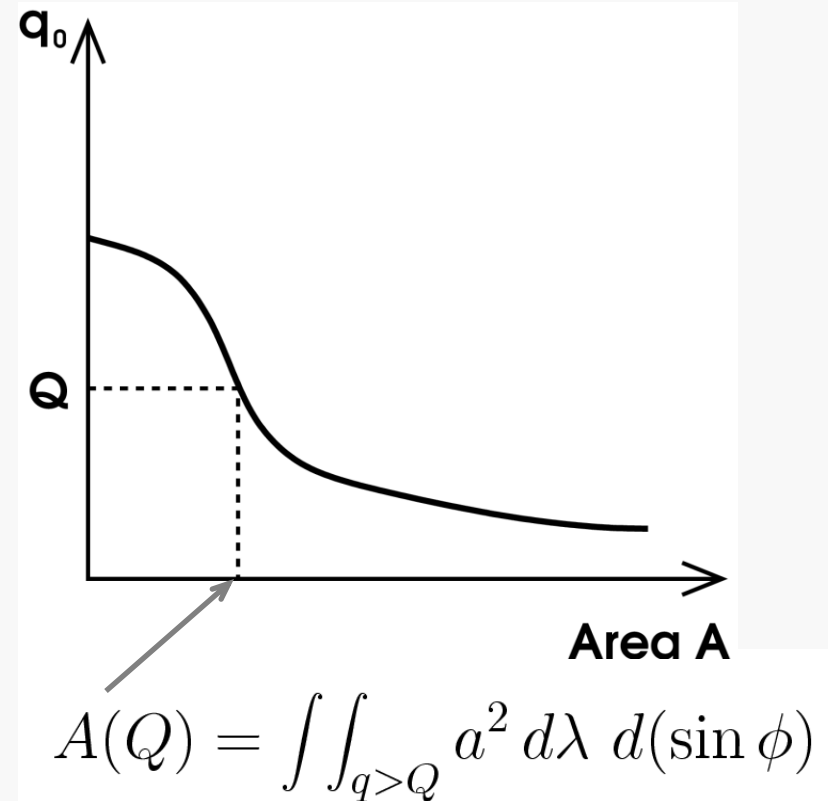

$$A(Q) = \int \int_{q>Q} a^2 d\lambda d(\sin \phi)$$

$$\frac{\partial q_0}{\partial t} = - \frac{\partial q_0}{\partial A} \oint_{q=q_0} \frac{S}{|\nabla q|} dl$$

E.g., a single layer model like the atmosphere

Snapshots of global PV

Rossby waves break, forming filaments which roll-up into eddies

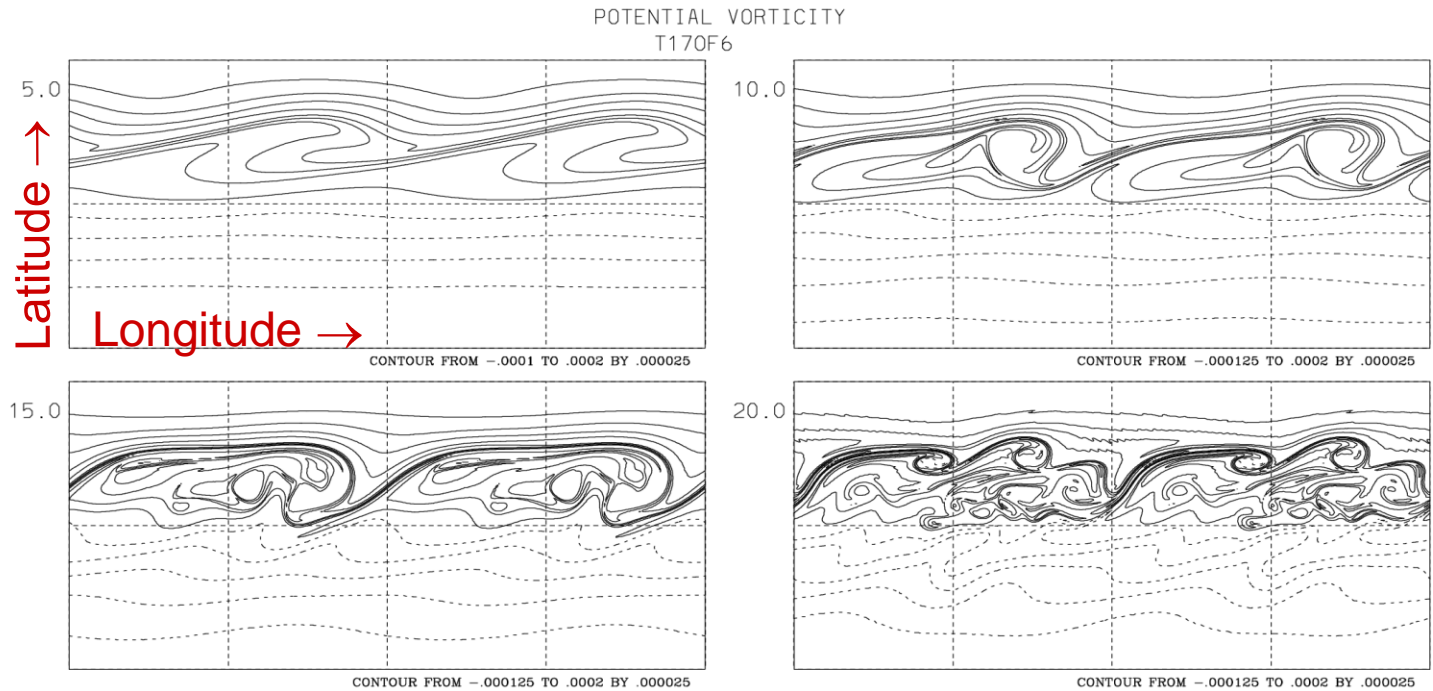

Evolution of background state PV

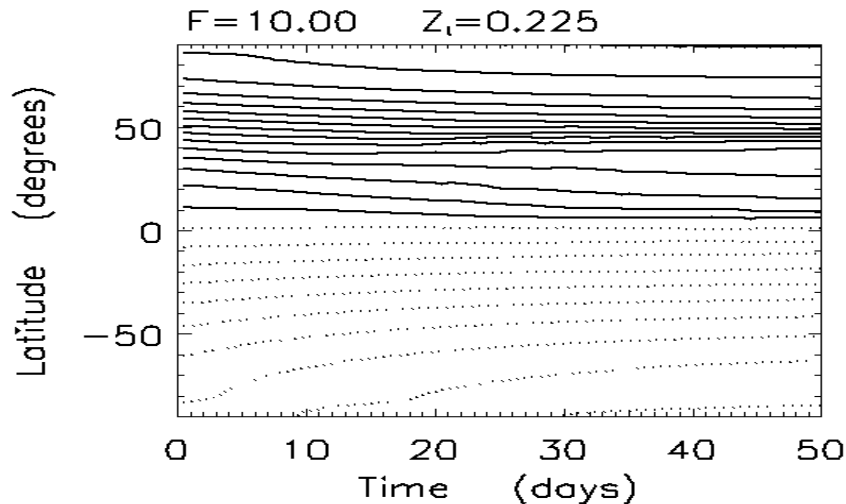

Global wave activity

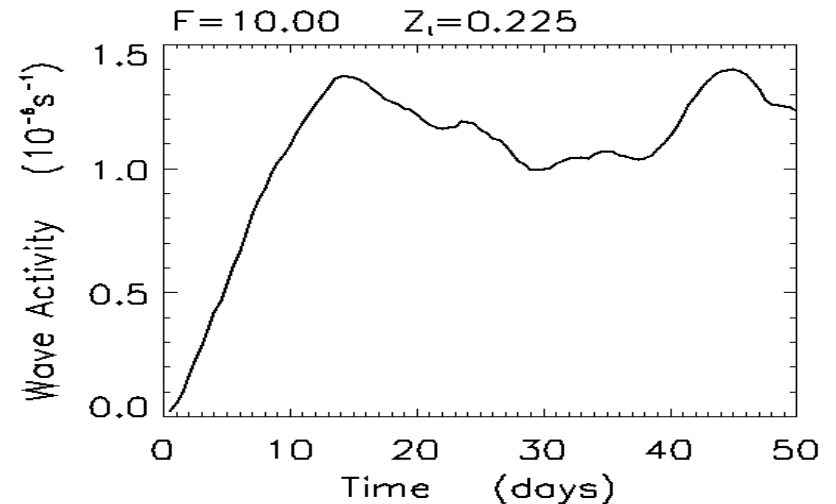

Modified Lagrangian Mean

- Background state PV is zonally symmetric.
- Obtained by *adiabatic rearrangement* from wavy 2D state, such that the area enclosed by each PV contour is conserved.
- *Equivalent latitude* = latitude at the southern edge of a polar cap with area matching the area enclosed by wavy PV contour.
 - Used by stratospheric community to diagnose ozone, water etc in polar vortex relative frame (McIntyre, 1980; Norton, 1994; Lary *et al*, 1995).
- A 2D MLM state can be found by re-arrangement of 3D wavy state conserving mass and circulation enclosed by PV contours.
- Can only evolve through non-conservative processes, so slowly varying.

Wave activity conservation

Theory of wave-mean flow interaction hinges on wave activity conservation laws. Linear QG version obtained from PV eqn:

$$\frac{\partial q'}{\partial t} + \overline{u} \frac{\partial q'}{\partial x} + v' \frac{\partial \overline{q}}{\partial y} = 0$$

x q' and take zonal average

$$\frac{\partial}{\partial t} \left(\frac{1}{2} \frac{\overline{q'^2}}{q_y} \right) + \overline{v'q'} = 0$$

↓ *Taylor identity*

$$\frac{\partial A}{\partial t} + \nabla \cdot \underline{F} = 0 \quad \text{Conservation law}$$

A = wave activity density

\underline{F} = Eliassen-Palm flux

$$\underline{F} = \left(-\overline{u'v'}, \frac{f_0 \overline{v'b'}}{N^2} \right)$$

Similar conservation law is obtained for large-amplitude disturbances in the primitive equations, but only if background defined by the MLM state (Haynes, 1988, JAS).

Rossby wave packets

Flux of wave activity in latitude-height section is associated with *group velocity* of Rossby wave packets, by formula:

$$\underline{F} = \underline{c}_g A$$

Hayes [1977], *Proc. Roy. Soc. London*
Edmon, Hoskins and McIntyre [1980], *JAS*

Wave activity increases where wave packets converge.

Ray tracing technique calculates paths of packets from group velocity.

Packet transports wave momentum great distances.

Considering the vorticity equation on a pressure level, Rossby waves are forced by the *Rossby wave source*, S :

$$\left(\frac{\partial}{\partial t} + \underline{v}_\psi \cdot \nabla \right) \zeta = -\nabla \cdot (\underline{v}_\chi \zeta) = S$$

Sardeshmukh and Hoskins (1988), *JAS*

Teleconnection patterns

Some rays are followed frequently because Rossby wave forcing occurs in same place and ray determined by flow.

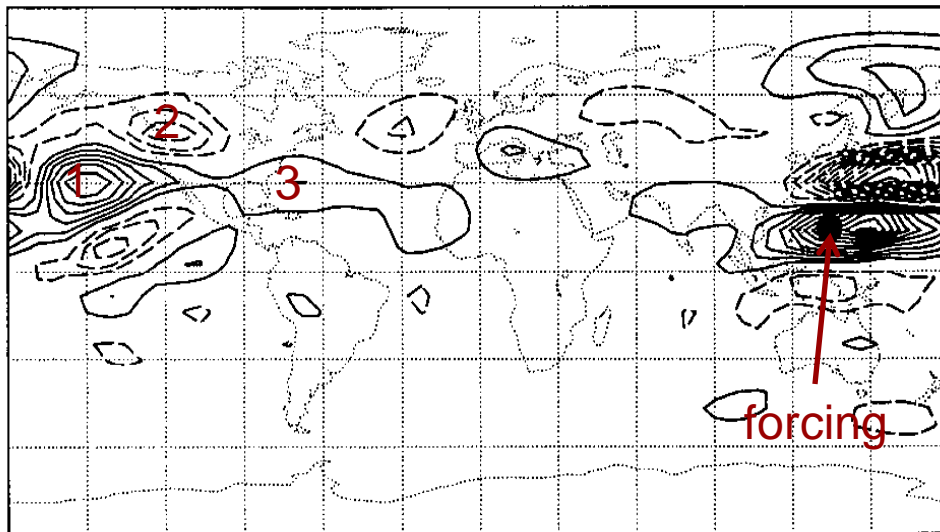

Stationary Rossby wave response to forcing in W. Pacific [Ambrizzi and Hoskins, 1993]

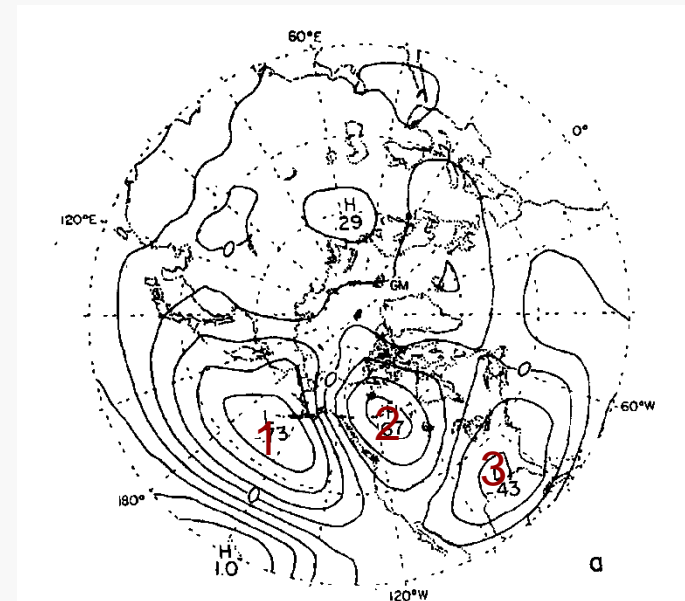

Correlation of height of 500hPa surface with time series at P.

Wallace and Gutzler [1981] called it the Pacific North American pattern.

An example of a teleconnection pattern

Linking extreme seasons to teleconnection patterns: e.g., UK, Autumn 2000

Mike Blackburn, NCAS-climate

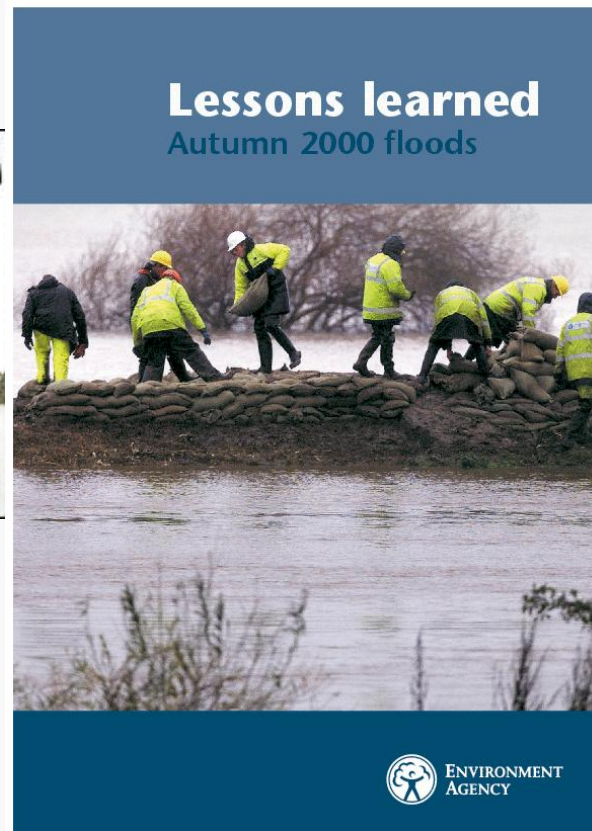

The historical context

300hPa Geopotential height

SON 2000 Anomaly

ECMWF analyses

Departure from ERA-15 climatology

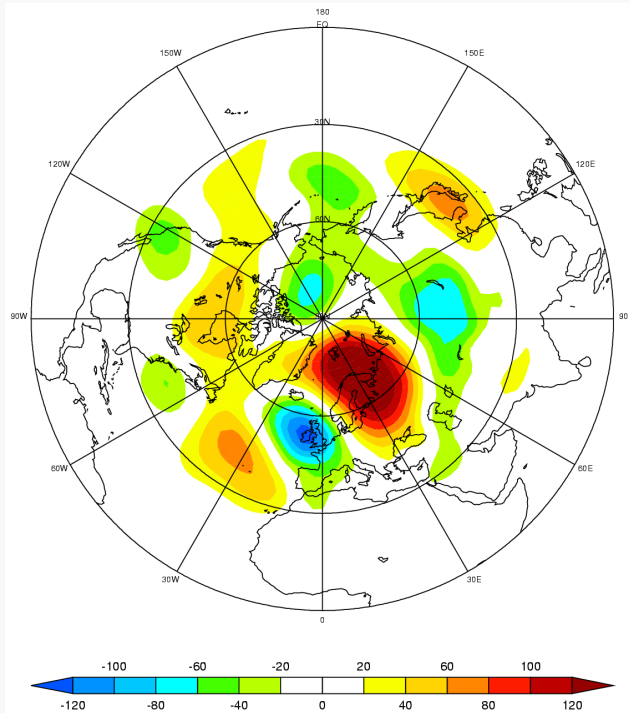

(metres)

Regression on England- Wales precipitation

SON 1958-1999

(bold: 99% confidence level)

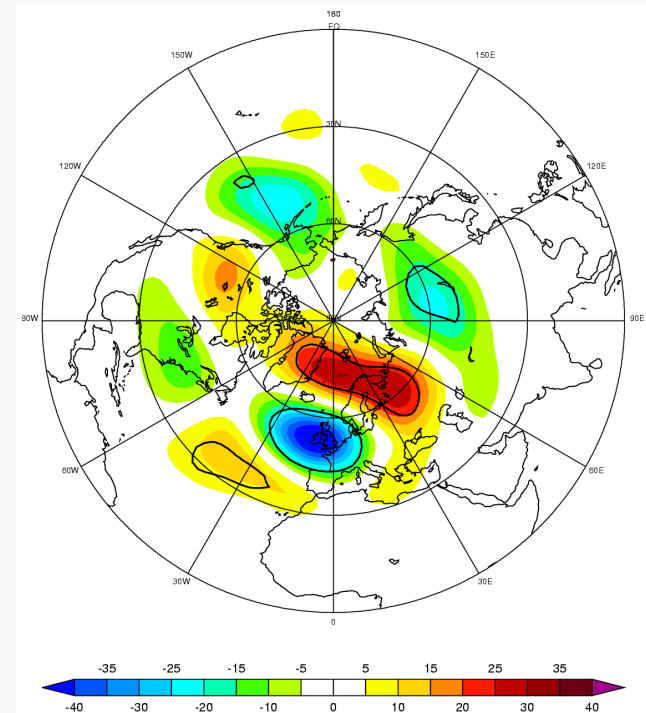

(metres for 1 Std Dvn precipitation)

Tropical forcing from south America?

200hPa Velocity Potential

NCEP CDAS/Reanalysis

Anomalies from 1979-1995 average

October 2000

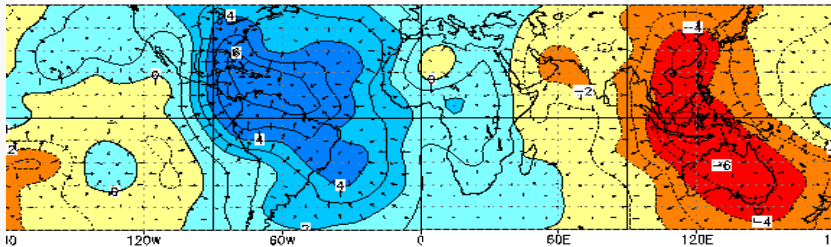

November 2000

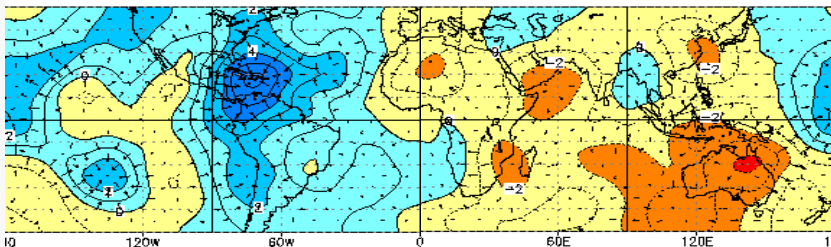

ECWMF Operational Analyses

Anomalies from 1979-1993 ERA-15 average

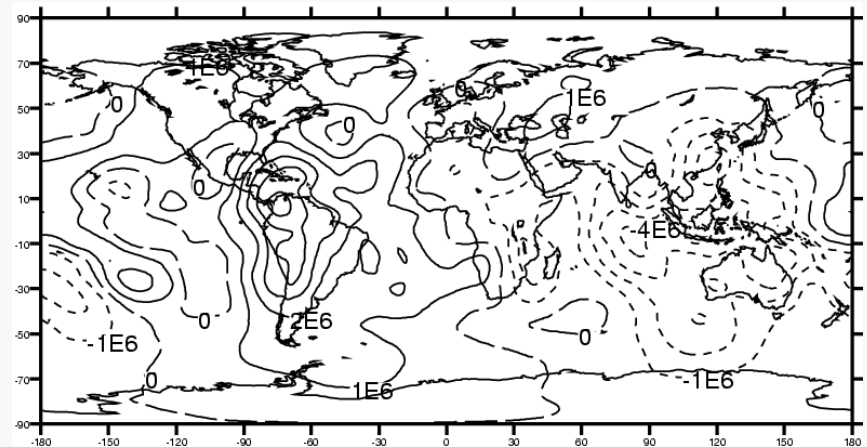
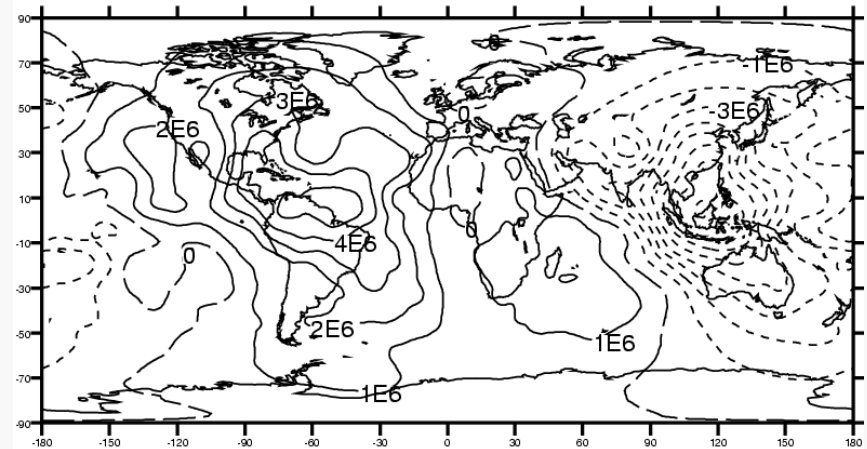

Barotropic model: response to idealised forcing

Barotropic model
Streamfunction anomaly
Day 15 (~steady state)

Model configuration:

- *SON climatology basic state*
- *Idealised convergence forcing*
- *Compare response (streamfunction) with analyses*

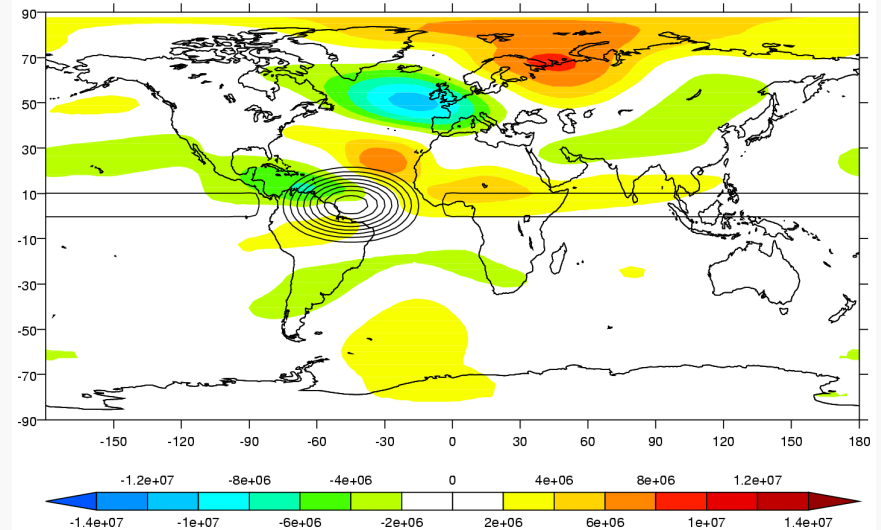

Analyses – SON 2000

300hPa Geopotential height

ECMWF analyses

Anomaly from ERA-15

Regression on England- Wales precipitation

300hPa Geopotential height

SON 1958-1999

(bold: 99% confidence level)

Barotropic model response

Streamfunction anomaly

Convergence forcing (45W;5N), $-fD$

SON climate 300hPa basic state

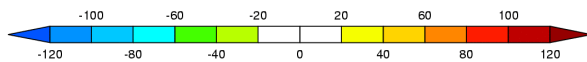
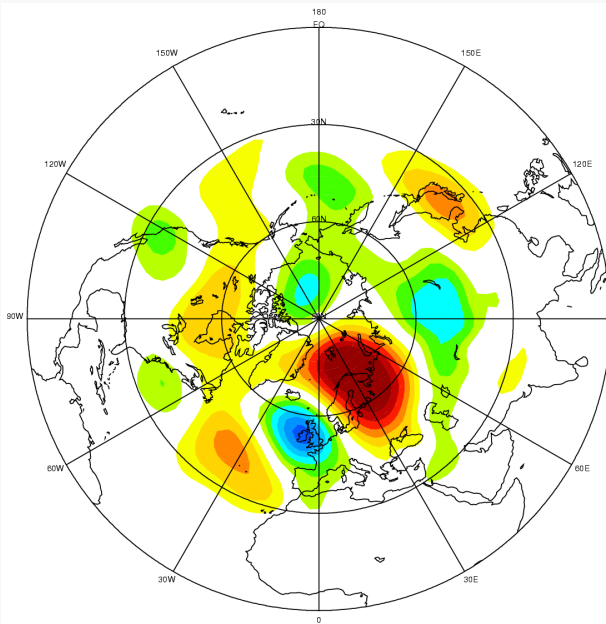

(metres)

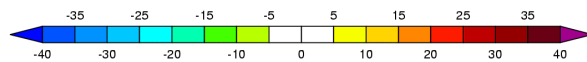
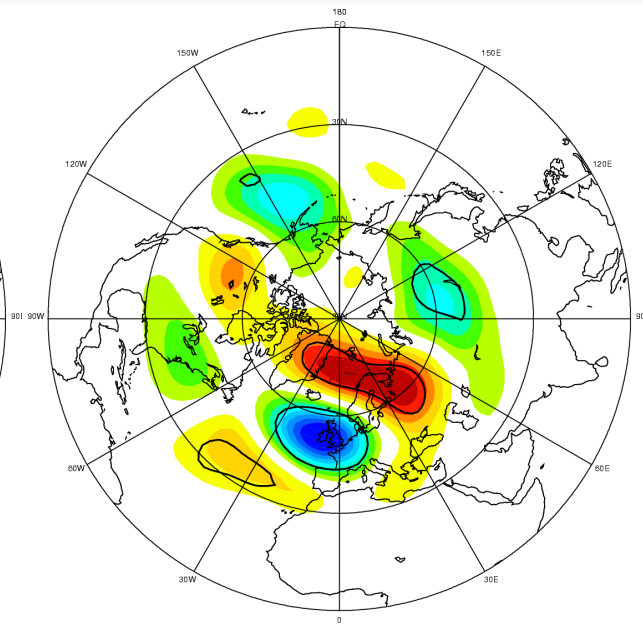

(metres for 1 Std Dvn precipitation)

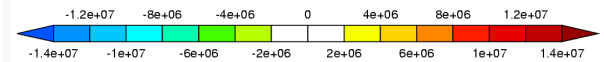
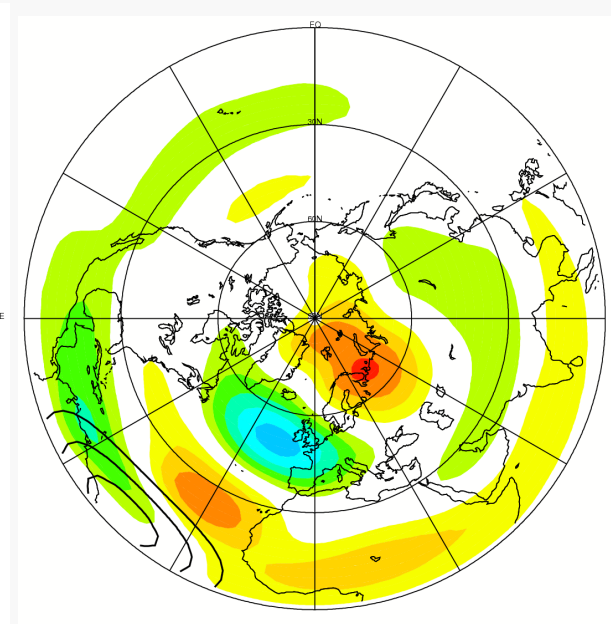

(Interval $2 \times 10^6 \text{ m}^2\text{s}^{-1}$)

Coherent (nonlinear) structures: Tracking cyclones

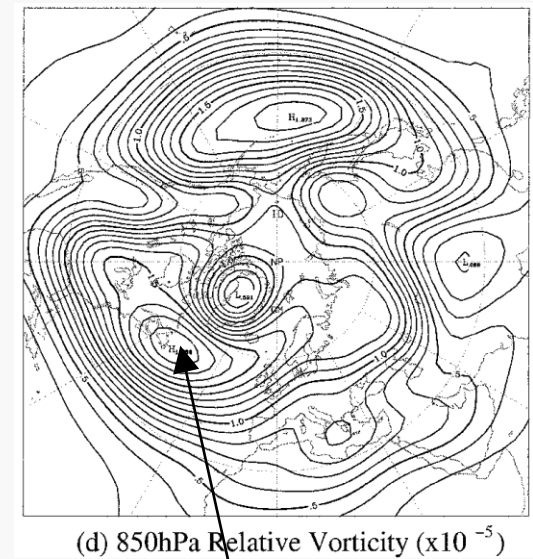
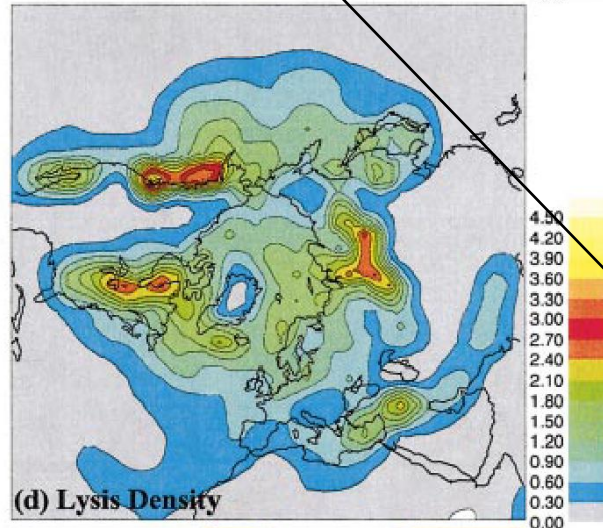
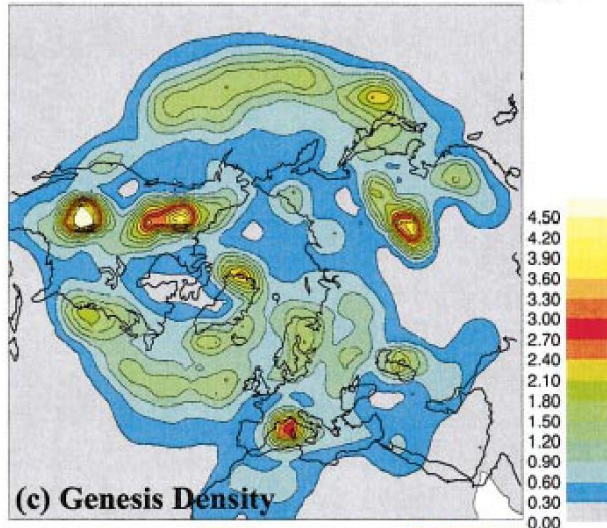
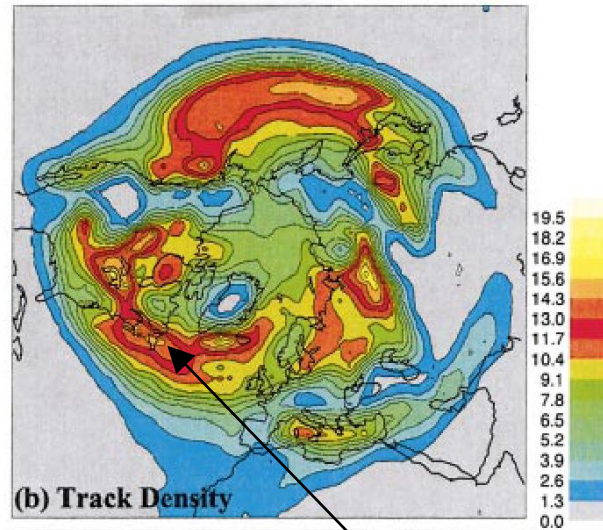
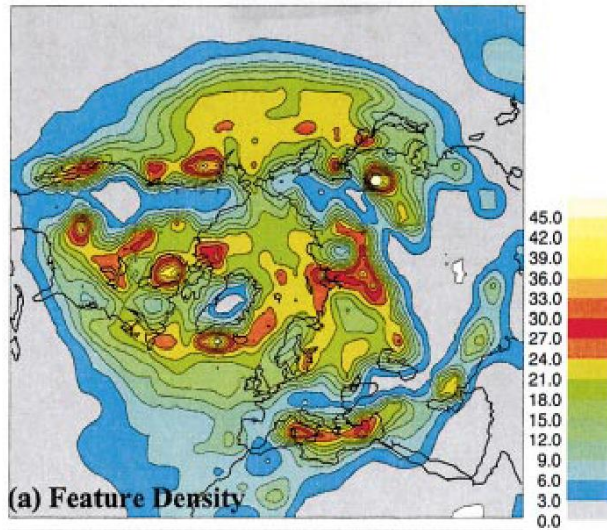

Vorticity variance
(band pass filtered)
versus cyclone
tracking as diagnostic
of stormtracks

Hoskins and Hodges
[2002], JAS

Stormtracks in lower and upper troposphere

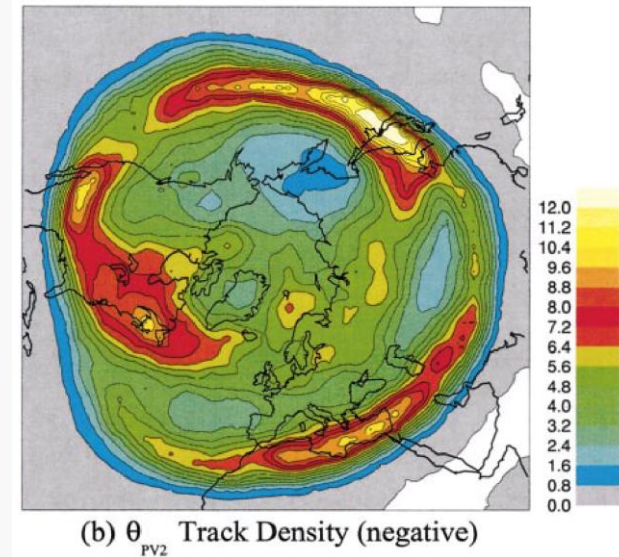
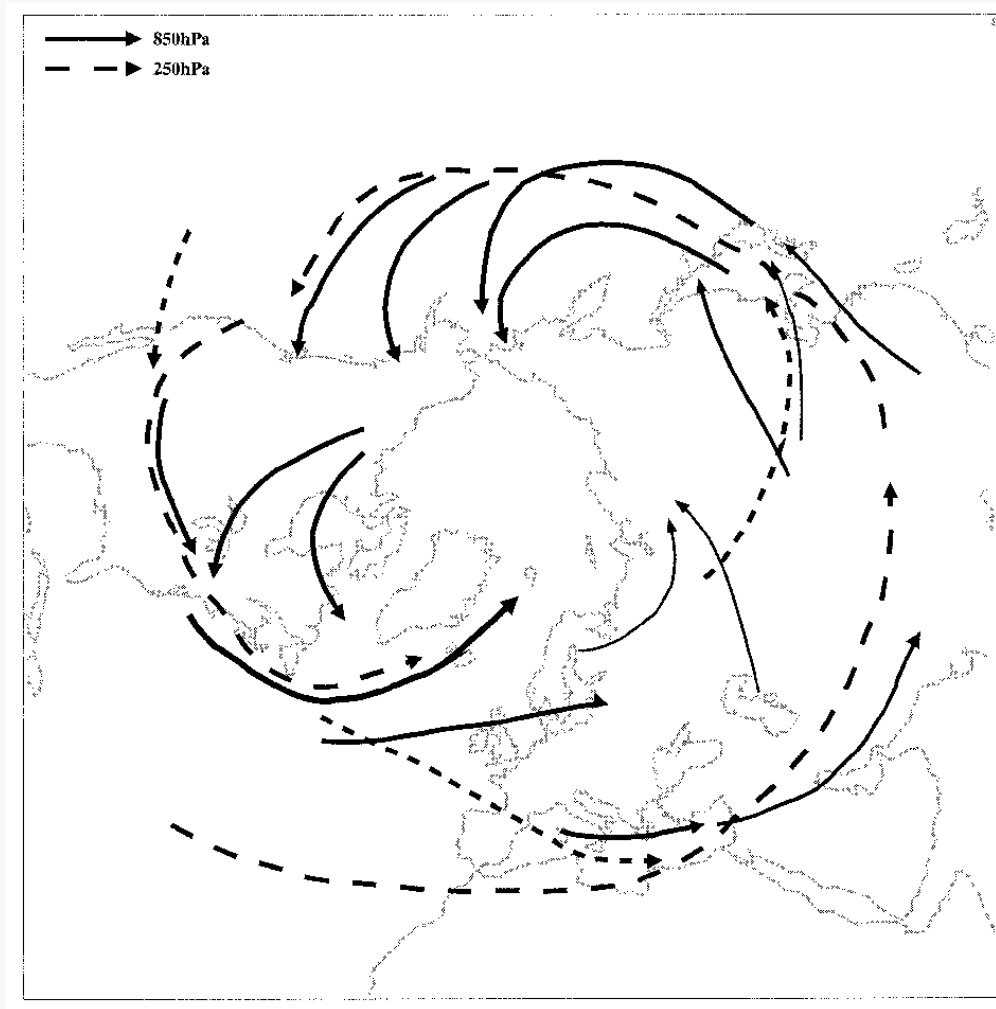

This schematic of most frequent cyclone tracks could not have been deduced from variance statistics. Also no need to apply time filter.

Creating cyclone composites

Diagnosing climate model deficiencies

Jen Catto, Len Shaffrey and Kevin Hodges

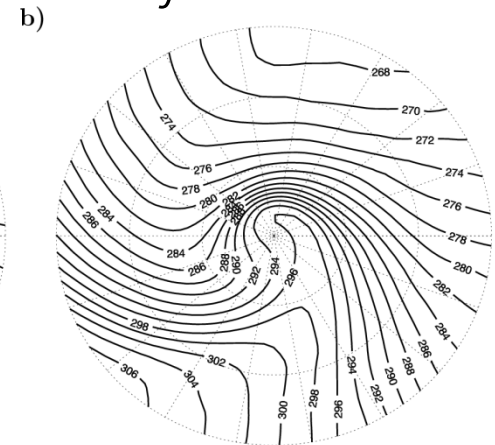
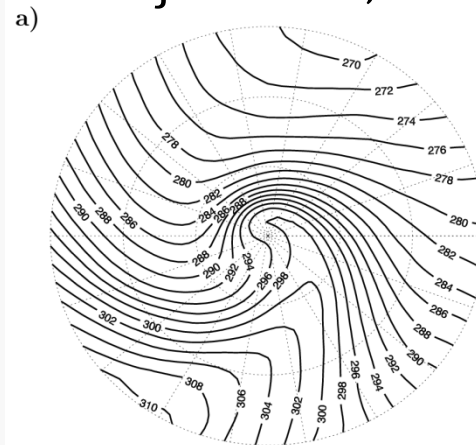
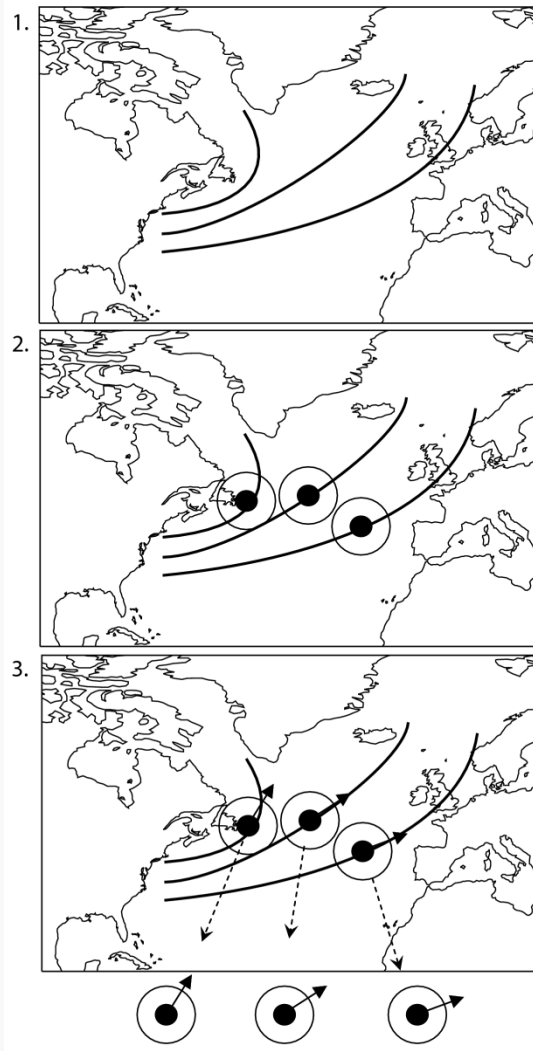

HiGEM climate model
(version of UM)

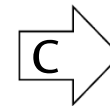

ERA40 composite

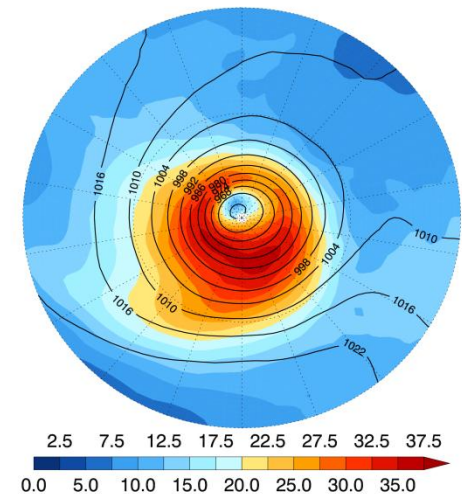
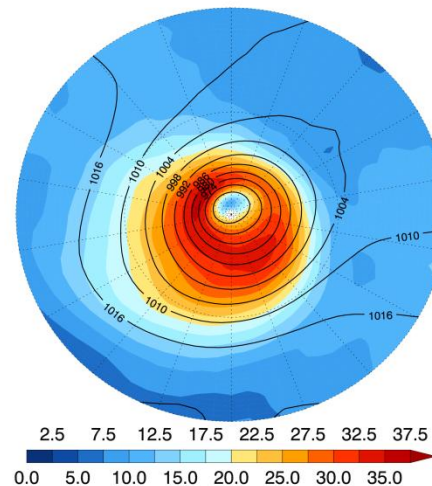

Cyclone tracks in ensemble forecasts

Lizzie Froude, ESSC, submitted to *Weather and Forecasting*

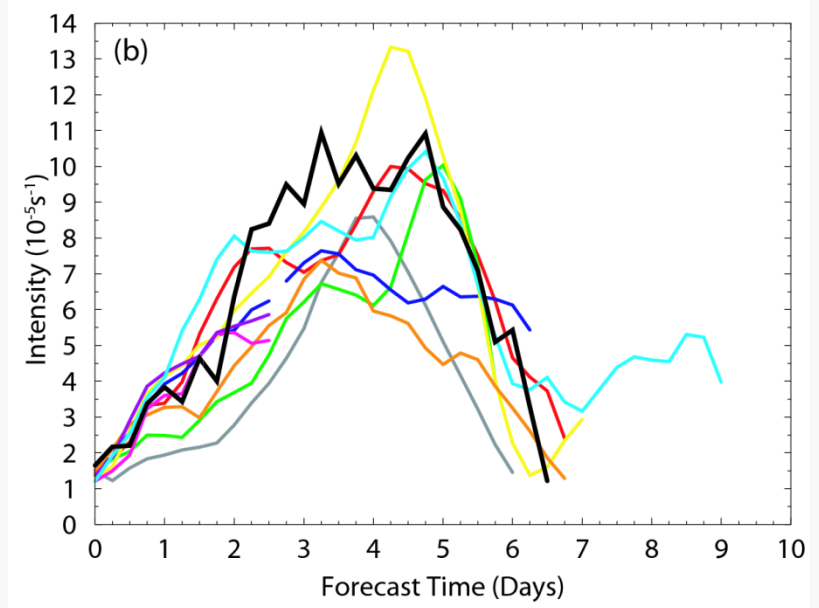
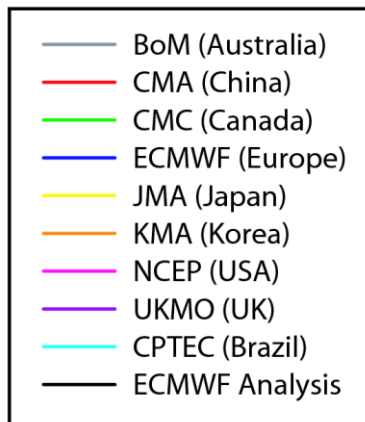
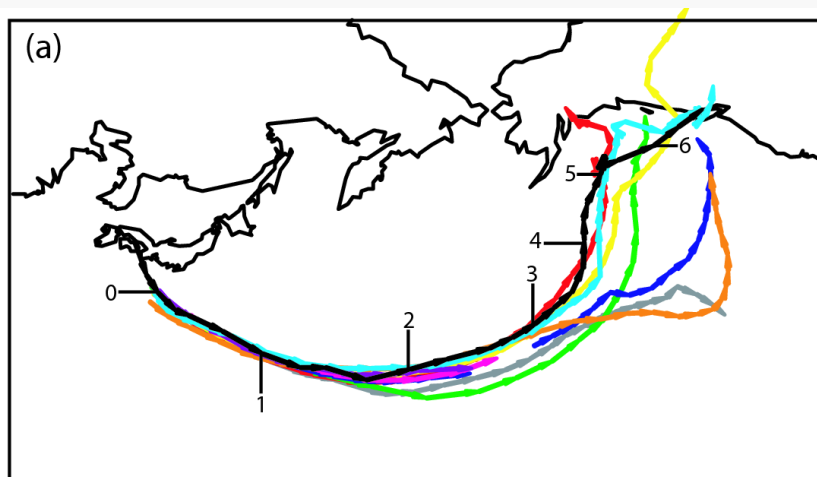

Using Kevin Hodges' cyclone tracking algorithm on ensemble forecasts from different centres archived on TIGGE database @ ECMWF.

Example of the control forecasts for one cyclone collated from 9 operational centres.

Bias in intensity and speed

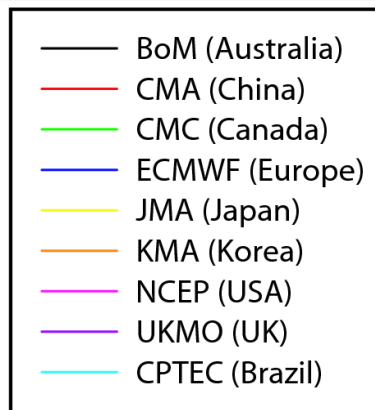
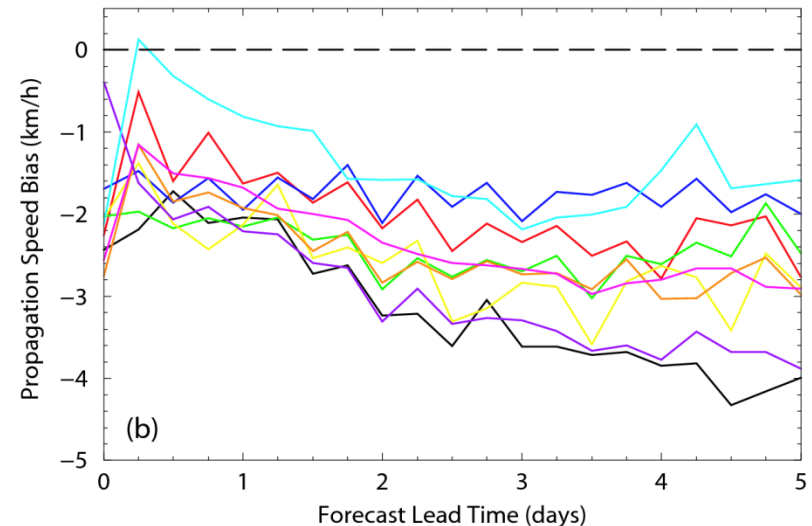
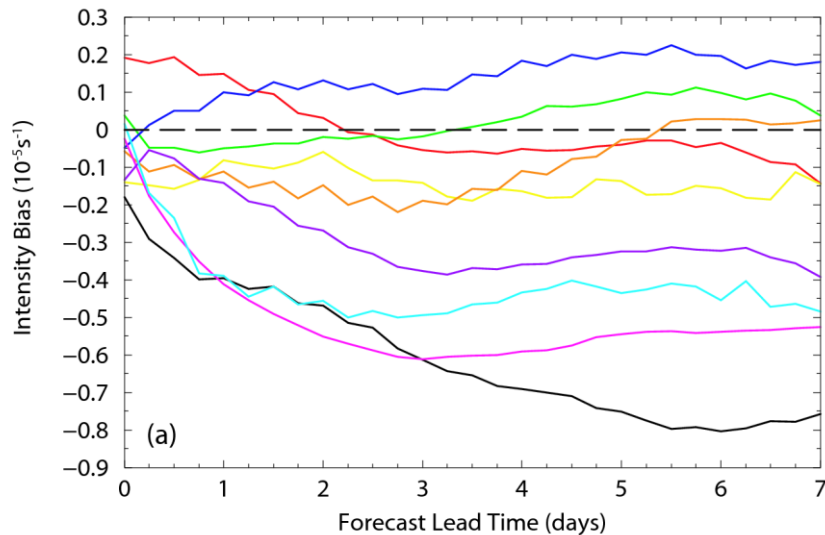

Forecasts from most centres underestimate cyclone intensity (except ECMWF, CMA, CMC).

Cyclones propagate too slowly in forecasts (feature of all centres).

3. Conclusions on mean flow and eddies

- Diagnosis of eddies and their effects on background flow depends critically on method used to define background state.
- Modified Lagrangian Mean state seems like a better way forward than Eulerian zonal or time average.
- Wave activity conservation laws provide crucial diagnostics of Rossby wave packet propagation and teleconnections.
- Extreme seasons often related to persistent almost stationary Rossby wave patterns (teleconnections). *Can exist in the absence of forcing, and Rossby wave “source” depends on wave, so cause and effect becomes muddy.*
- Cyclone tracking is valuable tool being used to evaluate models and ensemble forecast skill.

Summing up: Nature of the atmosphere

1. Transport

- Thermodynamic and chemical tracers carried vast distances
- ⇒ Complex source-receptor relationships.

2. Balance and PV

- PV anomalies *induce* flow at-a-distance.
- Inversion to obtain vertical motion or overturning circulations is also *non-local*.

3. Mean flow and eddies

- Waves forced in one location can propagate across globe and break/dissipate far away ⇒ *wave-transport*.
- Eddies affect one another via the influence they have on the mean state.

Beware regional budgets: action-at-a-distance, wave propagation and mass transport all create complex interplay between a region and its surroundings.

Summing up: Suitable Diagnostics

1. Transport

- Trajectories and tracer fields
- Advection-condensation models

2. Balance and PV

- PV as tracer and tracers for accumulated non-conservative effects
- PV error diagnostics
- Piecewise PV inversion and PV modification of forecasts

3. Mean flow and eddies

- Equivalent latitude coordinates for tracer diagnostics.

⇒ Modified Lagrangian mean state

- Teleconnections, Rossby wave source and wave activity flux.
- Cyclone tracking and composite analysis.