

Application and verification of ECMWF products 2018

METEO-FRANCE J. Stein, L. Aouf, G. Faure, N. Girardot, C. Maglione, O. Mestre, M. Pithon, D. Paradis, M. Plu, M. Riverain, I. Sanchez and M. Zamo

1. Summary of major highlights

ECMWF deterministic and ensemble forecasts have continued to be an important component of Meteo-France production, both as an input for the forecasters decision-making, as a digital products for the end users (usually after a calibration process that if more and more involving a probabilistic component and ensembles), and as a forcing for atmospheric and sea surface (waves and surges) models. Some of these products are made available as part of the COPERNICUS services (CAMS and CMEMS)

The major highlights for 2017/ 2018 have been:

- the operational implementation of Arome-ECMWF over Western Europe (2.5km resolution, initial conditions and hourly forcing provided by ECMWF BC project, see para 2.1.2 “Limited models”) in addition to the 5-daily Arome-Arpege, 1.3km version
- the provision of global wave forecasts driven by ECMWF winds and ice fraction data to the Copernicus Marine Environment Monitoring Services (CMEMS, see para 2.1.2 “Wave models”)
- Results from IFS deterministic model with high resolution are now used for forcing a new version of MOCAGE-Accident with a 0.1° domain around the emission source(see para 3.1.3 Emergency productions section)
- The increase in MOCAGE resolution to 0.1°, for the contribution to the COPERNICUS Atmospheric Monitoring Service (CAMS), planned for September 2018, requires the provision of IFS 00UTC and 12UTC forecasts with the appropriate resolution for atmospheric forcing.
- the kick-off given to the redesign project of Météo-France forecasts and product generation chain (3P); ECMWF deterministic and ensemble forecasts will be an important component of this multi-model, multi ensembles system; an example of direct model output post-processing is provided in para 2.1.3.
- ECMWF HRES forecasts are used as a component of a new expert aggregation for the statistical post-processing of temperature at 2 m AGL forecast.

2. Use and application of products

2.1 Post-processing of ECMWF model output

2.1.1 Statistical adaptation

Millions of local forecasts of weather parameters are produced daily through statistical adaptation of NWP output. Main methods are multiple linear regression (MLR) and linear discriminant analysis (DA). MOS (model output statistics) is generally preferred to PP (perfect prognosis). Kalman filter (KF) is applied when relevant. The production is described in Table 1.

Mixed ARPEGE+IFS over France statistical adaptation have been updated. They now mix raw forecasts and post-processed outputs with a new agregation algorithm (Winterberger, 2016).

Parameter	Method	Domain	Nbr of Sites	Steps
Tri-hourly 2m Temperature	MLR (MOS) +KF	France	2781	+3h to +180h by 3h
Daily extremes 2m temperature	MLR (MOS) +KF	France	2781	D to D+6
10m Wind Speed	MLR (MOS)	France	861	+6h to +180h by 3h
10m Wind Direction	MLR (MOS)	France	822	+6h to +180h by 3h
Total Cloud Cover	MLR (MOS)/LDA	France	164/152	+12h to +180h by 3h

Total Cloud Cover	LDA	France	GRID 0.5x0.5	0h to +156h by 3h
Tri-hourly 2m relative Humidity	MLR (MOS) +KF	France	1269	+6h to +180h by 3h
Daily extremes 2m rel. Humidity	MLR (MOS) +KF	France	1269	D to D+6
Tri-hourly 2m Temperature	MLR (MOS) +KF	World	7128	+1h to +180h by 1h
Daily extremes 2m temperature	MLR (MOS) +KF	World	7128	D to D+6
Mixed ARPEGE+IFS+AROME	Sequential agregation	France	2781	+3h to +102h by 3h
Mixed ARPEGE+IFS	MLR (MOS) +KF	World	4367	+1h to +102h by 1h

Table 1 : Statistical adaptations for the deterministic high resolution model

Ensemble (EPS)

* EPS Ensemble mean and individual members

Statistical post-processing is applied to individual ensemble members (Table 2). Methods are the same as for the deterministic model output but pseudo-PP (statistical equations computed during the first 24 hours then applied to the other corresponding steps) is preferred to MOS. VAREPS is used and Météo-France provides local forecast (temperatures) up to 14 days.

Parameter	Method	Domain	Nbr of Sites	Steps
Tri-hourly 2m Temperature	MLR (pPP) +KF	France	2761	+3h to +360h by 3h
Daily extremes 2m temperature	MLR (pPP) +KF	France	2761	D to D+14
10m Wind Speed	MLR	France	792	+6h to +240h by 3h +246 to +360 by 6h
Tri-hourly 2m relative Humidity	MLR (pPP) +KF	France	1146	0h to +240h by 3h
Daily extremes 2m rel. Humidity	MLR (pPP) +KF	France	1146	D to D+10
Tri-hourly 2m Temperature	MLR (pPP) +KF	World	3338	+0h to +360h by 3h (by 1h for ensemble mean)
Daily extremes 2m temperature	MLR (pPP) +KF	World	3338	D to D+14

Table 2 : Statistical adaptations for the EPS

* EPS Distribution

Calibration is applied to the EPS distribution in order to improve the reliability. Operationally, a calibration based on rank diagrams is used for 10m wind speed and total precipitations. The post-processing and calibration of ensembles has become an important component of Meteo-France research and development (e.g. Zamo, 2016), and will become an important part of the forecast and production re-engineering project (3P)

2.1.2 Physical adaptation

Limited –area models

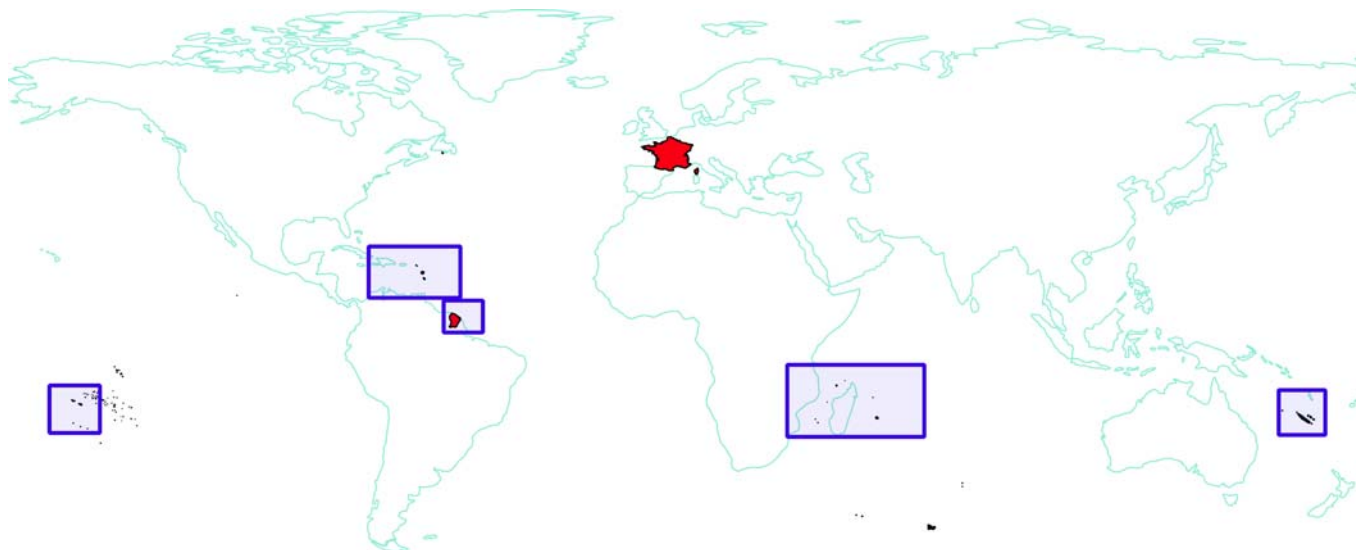

Fig. 1: Five Limited Area Model, based on AROME, are operated by Météo-France to provide high-resolution forecasts for tropical area including French overseas territories (Figure 1). Their horizontal resolution is equal to 2.5 km. ECMWF-HRES provides their initial and boundary conditions. Four daily runs are performed at 0, 6, 12 and 18 UTC, with a maximum lead time of 42 hours. The surface conditions are provided by the French global model ARPEGE.

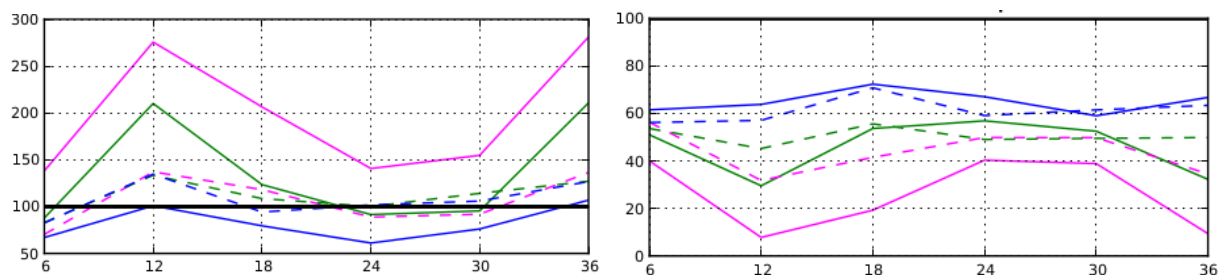

Fig. 2: Frequency bias (left) and miss ratio (right) for three thresholds 0.2mm/6h (pink) 2mm/6h (green) and 10mm/6h (blue) 6 hours precipitation forecasts performed by the AROME-ECMWF (dashed lines) and IFS (full lines). The scores are computed against the French rain gauge network operated in La Réunion (Indian Ocean) for one year (july 2017-june 2018) and are displayed for each six hours forecast lead time.

Improvements have been made on underestimation of AROME-ECMWF total precipitation during the 6 first hours of forecast; AROME-ECMWF precipitation bias is better than the year before. This is due to a new mixing of IFS analysis and 6-hours AROME-ECMWF forecast of the previous run to build the initial condition for AROME-ECMWF forecast. For longer lead times, the local adaptation tends to correct the important overestimation of light rains by IFS and also the underestimation of strong thresholds. This reduction of overestimations leads to fewer false alarms (not shown) but increases misses especially for the 0.2mm/6h threshold.

Moderate rains, 2mm/6h threshold, show similar behaviour for bias: reduction of IFS overestimations but the misses are still slightly higher than IFS misses. Heavy rains, 10mm/6h, are underestimated by IFS and corrected by AROME-ECMWF. This difference produces more false alarms for AROME-ECMWF than IFS (not shown) but a benefit in misses even if they remain rather frequent.

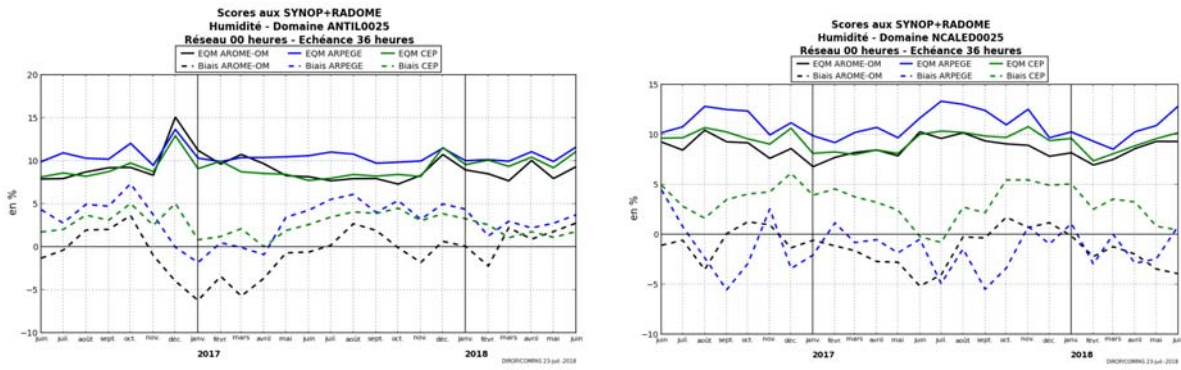

Fig. 3: Temporal series of the RMSE (full lines) and bias (dotted lines) for relative humidity at 2m AGL forecasted at 36 hours of lead time by AROME Antilles (black lines) ARPEGE (blue lines) and IFS (green lines) on the left panel. The reference is provided by the surface stations included in the LAM domain and the errors are monthly averages. The same comparison is presented for the AROME-Nouvelle Calédonie on the right panel at 36 hours.

The temporal series of the RMSE for the relative humidity at 2m AGL present different bias over both areas between AROME-ECMWF and IFS. RMSE are improved by AROME-ECMWF and the differences are more pronounced over the Antilles domain in favour of AROME since the operational changes of December 2017. Over the NOUVELLE CALEDONIE area, IFS tends to overestimate humidity most of the year but with an annual cycle giving the better biases during austral winter; AROME-ECMWF reduces IFS biases, biases are correct most of the year but tends to underestimation during the winter, and improve humidity RMSE for any month.

A new version of the limited area model AROME has been implemented at Météo-France using ECMWF HRES forecasts as boundary conditions and initial altitude fields ; initial surface conditions are provided by AROME-France. AROME-ECMWF is run twice per day, at 0 and 12 hours UTC for 48 hours maximum range and its horizontal resolution is 2.5km.

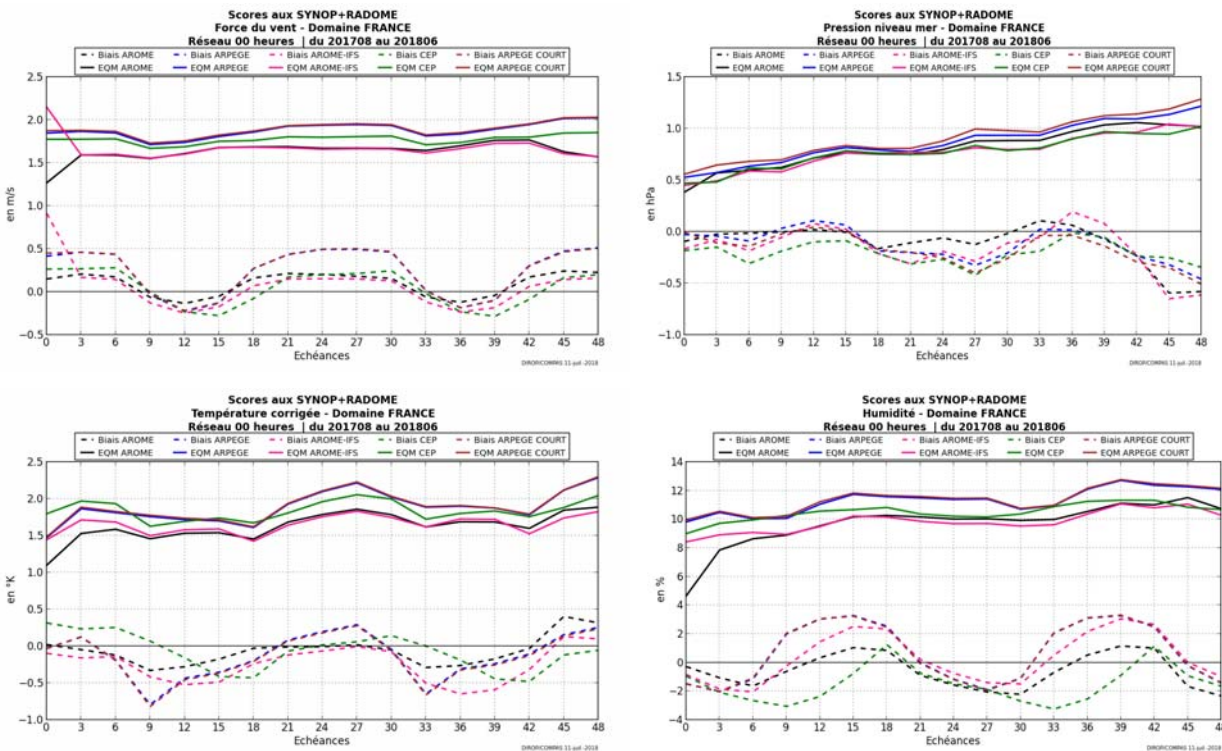

Fig 4 : Annual Bias (dotted lines) and RMSE (full lines) for surface parameters : wind force (top-left) mean seal level pressure (top-right) temperature at 2m AGL(bottom-left) and humidity at 2m AGL (bottom-right) forecast ranges 0 to 48 hours by AROME-France(black) ARPEGE (blue) IFS-HRES (green) and AROME-IFS (magenta)

Major differences between AROME-France (black line) and AROME-ECMWF (magenta) scores occurs at very short ranges for most of the surface parameters: as AROME-IFS starts without its own assimilation, 0 hour forecast errors are slightly

stronger than AROME-France errors. But differences become smaller as forecast ranges grows : for most of surface parameters, AROME-France and AROME-IFS errors are close and often better for AROME-IFS forecasts of MSL pressure.

Diurnal cycles of temperature and humidity bias are more pronounced with AROME-IFS in comparison to IFS-HRES and AROME-France: underestimating during the day for temperature is correlated to over-estimating humidity.

The benefit of AROME-IFS relative to IFS-HRES is obvious for most parameters as RMSE are reduced; for only MSL pressure, both models share the same performance

Wave models

The operational wave model MFWAM was upgraded in April 2018 with a better grid resolution up to 10 km globally and improved physics dedicated to the coupling with ocean circulation model NEMO in the frame of Copernicus Marine Service (CMEMS-MFC-GLO). The model MFWAM of Meteo-France is based on the ECWAM code (IFS-38R2), but uses a different physical package including the dissipation by wave breaking and the damping of the swell induced by the air-friction at the sea surface. The model is driven by deterministic wind field and ice fraction provided by the IFS-ECMWF atmospheric system. The atmospheric forcing is used 6-hourly in the analysis and 3-hourly in the forecast period up to 120 hours. The model MFWAM assimilates the altimeters wave data (Jason-2, Saral/Altika, Cryosat-2, Jason-3 and Sentinel-3A since May 2018).

The global model MFWAM is among the best wave forecasting system regarding to monthly inter-comparison of JCOMM, as illustrated in Fig. 5, which shows the variation of normalized scatter index of significant wave height in the analysis and forecast periods during May 2018. The performance of the global MFWAM system regarding to altimeters wave data shows a good scatter index of significant wave height roughly less than 10% during the 12-hour forecast, as illustrated in Fig. 6 for June 2018. The highest scatter index is located in coastal areas, while the lowest scatter indexes are observed in the intermediate latitudes and the tropics.

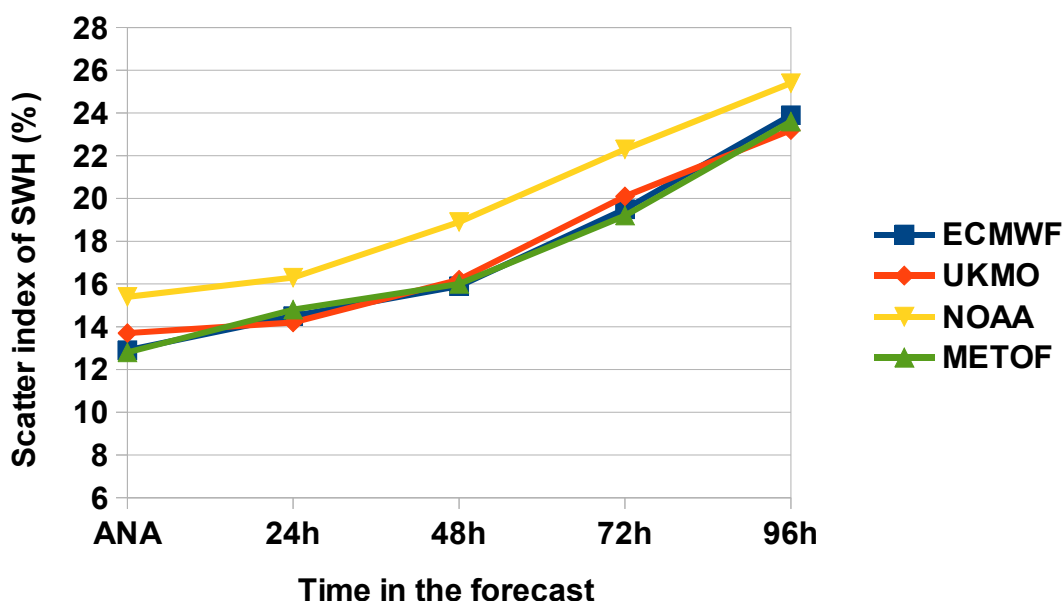

Fig. 5 Monthly Scatter index of significant wave height from the JCOMM inter-comparison with buoys on May 2018. Green, blue, red and yellow colors stand for Meteo-France, ECMWF, UK Met-Office and NOAA/NCEP systems, respectively. The smaller scatter index, the better wave forecast is.

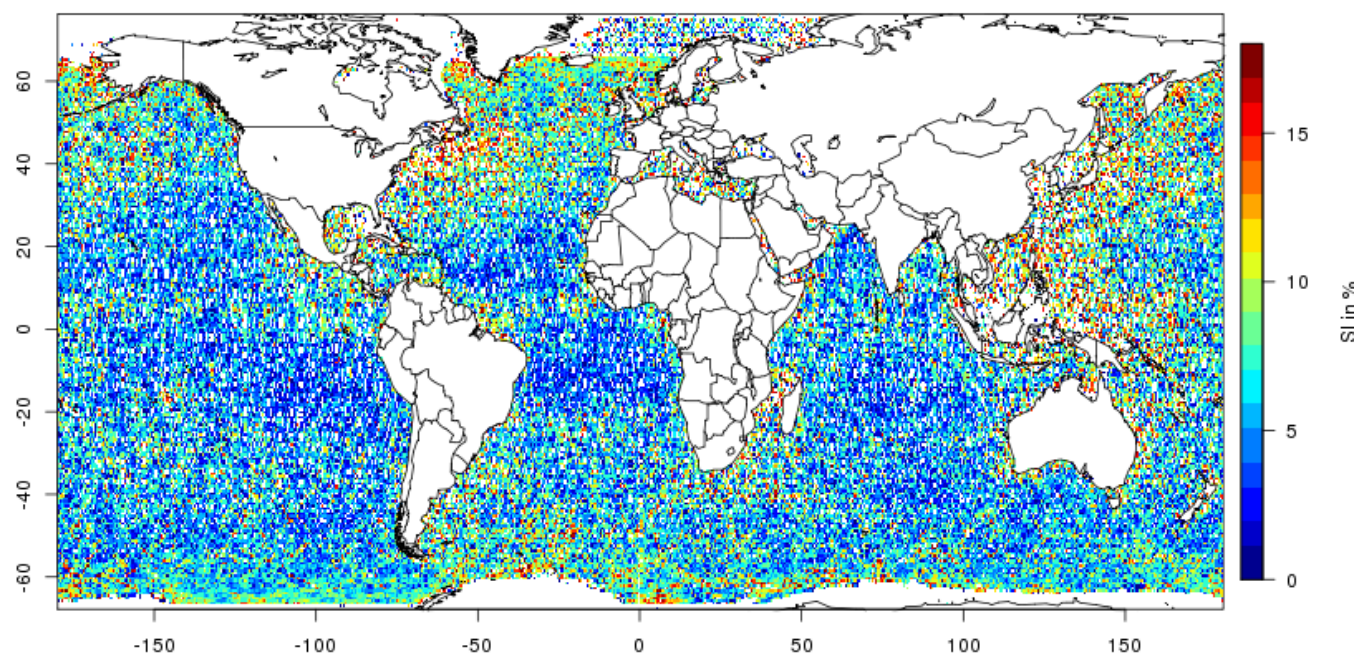

Fig. 6 : Map of normalized scatter index of significant wave height during the 12-hour forecast of the global MFWAM system driven by ECMWF forcing for June 2018. The comparison is performed with 3-hourly window altimeters wave data during the 12-hour forecast.

Storm surge model

The Météo-France storm surge model for the west european coasts is operated 13 times per day in order to use a variety of atmospheric forcings and to allow the forecasters to know the impact of each forcing on the sea level (west european coasts). Thus, the medium range deterministic forecasts of ECMWF are used as forcing, beside the Arpege and the Arome atmospheric models of Météo-France.

The Météo-France storm surge model, used since the 14th January 2014 and regularly improved (finer resolution, better physics), has been developed by SHOM and Météo-France in the framework of the french HOMONIM project (Historique, Observation, MODélisation des NiveauxMarins). It is based on a barotropic version of the HYCOM code (<https://hycom.org/>). Two domains, ATL (BiscayeBaye, Channel and North Sea) and MED (Méditerrananean Sea) have been implemented, with a resolution of around 600 m for ATL and 1000 m for MED (curvilinear grids). The bottom friction of ATL has been optimized to reproduce the tides at the best. A validation has been done on 22 storm events and on a one year simulation, to calibrate the drag coefficient. Up to date bathymetries have been used.

The one year simulation presents a mean bias of -2 cm. The negative bias is stronger when only high storm surges are taken into account : -5 cm.

For the 22 events, the mean error on the max storm surge peak is around -10 cm (-8 cm on the maximum of the sea level) and the mean time error is 34 minutes.

The operational suite include 4 forecasts a day for this model using Arpege forcing (at 0, 6, 12 and 18 UTC with forecasts until 102, 72, 114 and 60 h respectively), 5 forecasts with AROME forcing (at 0, 3, 6, 12 and 18 UTC with forecasts until 42, 39, 360, 3642 and 4236 h respectively), and 4 simulations with IFS/HRES forcing (at 0, 6, 12 and 18 UTC with forecasts until 120, 90, 120 and 90 h respectively).

In 2017, two other configurations of the storm surge model have been added : one for the West Indies and the French Guyana (variable horizontal grid size, from 900 m to 2 km) and the other for the SW of the Indian Ocean (horizontal grid size of 3 km). These models are run 4 times a day (forecasts up to 42h), with an AROME forcing, completed by the ECMWF winds and sea level on the area not covered by AROME.

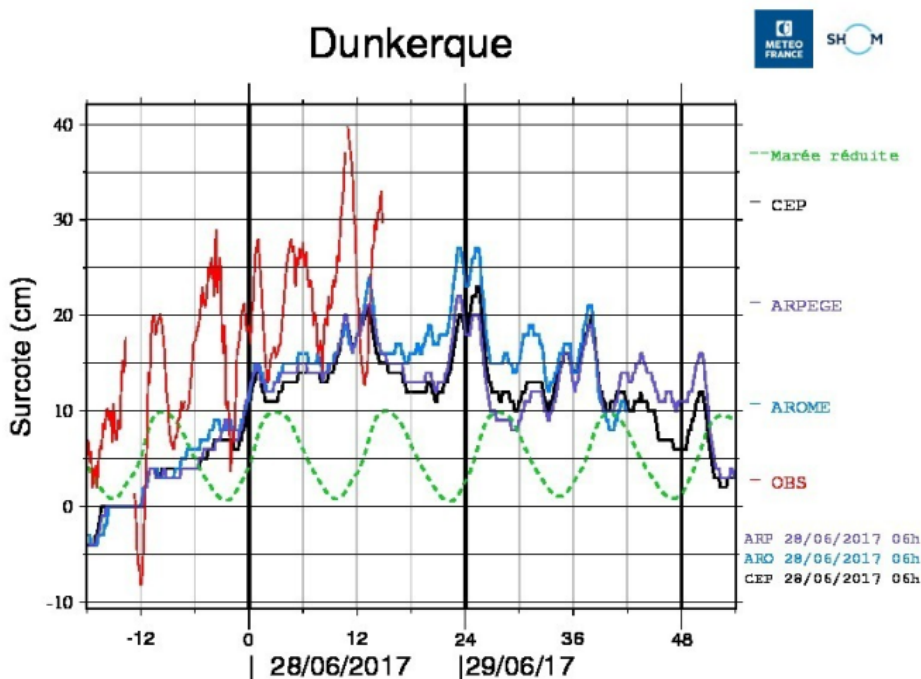

Fig. 7: Temporal series (every 10 minutes) for the storm surge (and the total sea level) forecasted at Dunkerque (North of France) starting the 28/08/2017 at 6 UTC. They are forecasted by the Hycom2D model using the forcing provided by the global model IFS (black), the French global model ARPEGE (purple) and the LAM AROME (blue). The red line represents the observations (tide gauges).

The storm surge (and the total sea level) forecasts are mainly visualized as temporal series (every 10 minutes) on specific points of the coast. Fig 7 displays the forecasts at Dunkerque (North of the France) starting the 28th June 2017 at 6 UTC : the black line represents the storm surge computed with the IFS forcing and the red line the observations (tide gauges).

2.1.3 Derived fields

As part of the re-engineering of Météo-France product suite, a new algorithm has been developed to generate weather pictograms on a global scale using ECMWF deterministic forecasts (Fig. 8)

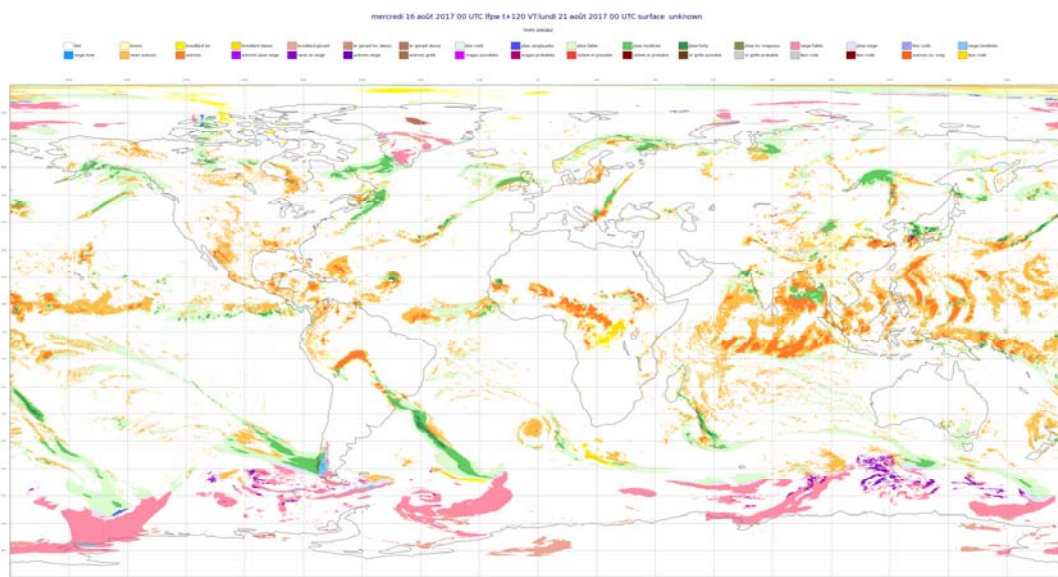

Fig. 8: Example of weather parameters used for pictogram generation over the globe using ECMWF forecasts.

2.2 ECMWF products

2.2.1 Use of Products

2.2.2 Product requests

3. Verification of products

3.1 Objective verification

3.1.1 Direct ECMWF model output (both HRES and ENS)

The parameter VISIBILITY forecasted by HRES model has been verified against observations by visibility sensors mainly located on the French airports ; the period of verification, the autumn 2017, was favourable to mists and early fogs over France.

For the ICAO visibility thresholds (150, 350 , 600, 800, 1000, 1500, 3000, 5000 m) contingency tables were built for the first day of forecast, ranges 3 to 24h, by 3hours. Frequency bias are presented below : for very low visibility thresholds, lower than 150m, forecasts are more frequent than observations with a maximum ratio of 6 forecasts for 1 observation at 6hUTC ; the 350m threshold gets better biases for night-visibilitys but forecasts underestimate this threshold during the day.

For higher thresholds, underestimating is regular with approximately 50% of frequency bias, except in the afternoon where biases are corrects for 3000 and 5000m. As a logical consequence, probabilities of detection are low and the Peirce Skill Scores reflects the lack of forecasts for most of the studied threshold of visibility. For ranges 12, 15 and 18 hours, low visibility forecasts are extremely rare and mostly cause false alarms.

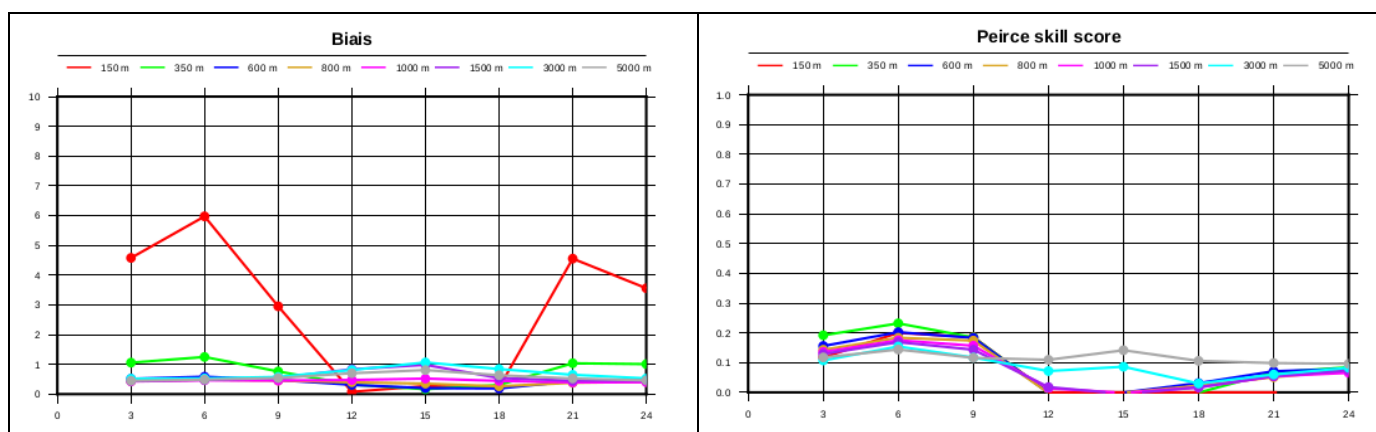

Fig 5: Frequency biais (left) Peirce Skill Score (right) HRES visibility forecasts - autumn 2017 ICAO thresholds 150 (red) 350 (green) 600 (navy) 800 (yellow) 1000 (magenta) 1500 (purple) 3000 (grey) 5000 m(cyan)

3.1.2 ECMWF model output compared to other NWP models

3.1.3 Post-processed products

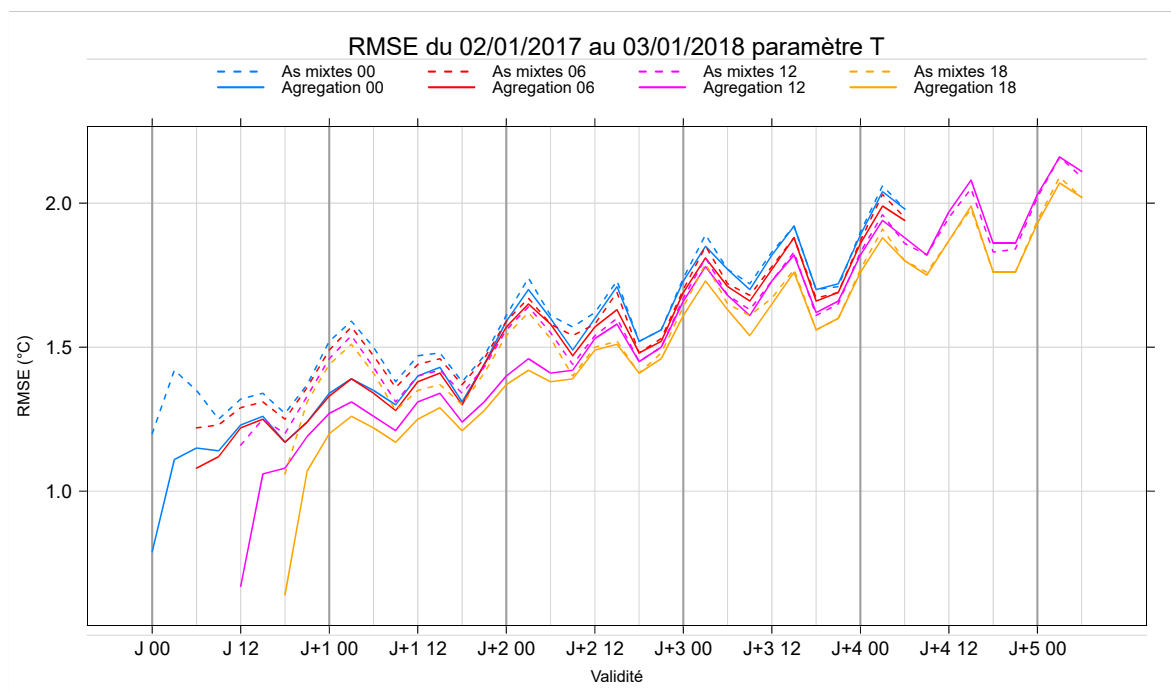

Fig.9 Evolution of the root mean square error with the lead time of mixed temperature model output statistics for the four runs. The previous version of mixed MOS (As mixtes) corresponds to the dashed lines, the new version (agregation) to the continuous lines. The verification period is from January 2017 to December 2017.

The use of a new aggregation algorithm with more NWP outputs (in particular use of AROME-FRANCE forecasts for day J and J+1) leads to an improvement in forecasts performance especially at short lead times.

EMERGENCY PRODUCTIONS : Pollutant transport and dispersion forecast

For the long-range dispersion forecast, two tools operated by Météo-France to assess impacts in case of an accidental release can make use of IFS meteorological forcings, if appropriate :

- An air mass trajectory tool computes simple lagrangian trajectories. Three neutrally buoyant particles are released in the atmosphere at a geographic location defined by the user and at three fixed vertical levels: 950, 850 and 700 hPa, corresponding to about 500, 1500 and 3000 m above sea level in standard atmosphere. The particles are only subjected to the action of the large-scale wind; no other physical or atmospheric process is taken into account. The 3-D wind field is provided either by the global NWP models ARPEGE from Météo-France or by IFS from ECMWF (choice of the user) sampled at 0.5° resolution and on 15 vertical pressure levels, from 1000 to 100 hPa. The tool provides a quick estimate of the expected trajectory of air parcels originating from the planetary boundary layer at the location of interest.
- A dispersion model, MOCAGE-accident, based upon the MOCAGE three-dimensional chemistry and transport model developed by Météo-France for the numerical simulation of the interactions between dynamical, physical and chemical processes in the lower stratosphere and in the troposphere. MOCAGE-accident is a version of MOCAGE specifically adapted for the transport and diffusion of accidental release from the regional to the global scale. Currently, only dynamical and physical processes are taken into account, excluding chemistry.

MOCAGE-accident runs in off-line mode, using Météo-France ARPEGE or ECMWF/IFS operational NWP products as dynamical forcings.

For this long-range dispersion forecast, IFS meteorological forcing over the domain needed are extracted from Météo-France operational Data bases, with fields disseminated to these databases from ECMWF, main fields used are the temperature, the humidity, surface pressure and the wind related fields. The 9km IFS resolution has enabled, since June 2017, the development of a new version of MOCAGE-Accident with a high resolution domain around the source term and forecast steps to 144h ahead.

For local and regional scale dispersion forecast, Météo-France uses the system PERLE which is based on the combination of a mesoscale non hydrostatic model, which provides meteorological fields, and a lagrangian particle dispersion model (LPDM, from the Colorado State University), the formulation of which allows the description, during the first critical few hours, of the atmospheric pollutant cloud in the vicinity of a radionuclide or chemical release, without gaussian assumptions.

For the standard PERLE version, which is run over France in operations, the meso-scale meteorological fields considered are either AROME operational forecasts or specifically produced forecasts by the Meso-NH model (Lafore et al., 1998). In the case where Meso-NH is chosen, it uses two nested grids for emergency response, with a first domain covering 500km*500km

area (4-km resolution) and a second domain covering 100km*100km area (1-km resolution), and two-way interactions between them. The initial and boundary conditions of the larger domain are provided by ARPEGE.

In 2011, a “global” version of PERLE has been developed and can be used for any limited area domain over the globe, by considering IFS fields for both initial and boundary conditions of Meso-NH. TC3 tasks at ECMWF are triggered automatically upon reception of a configuration file to provide the necessary fields at a 0.1° resolution, extracted from MARS database.

For this local and regional scale dispersion forecast, IFS meteorological forcing (temperature, humidity, and wind fields are extracted) over the domain needed.

Since July 2017, it is possible to run the PERLE model for past dates (using IFS data sets with MARS access).

CAMS

The MOCAGE chemistry transport model of Météo-France is operated daily, to provide air quality forecasts and analysis, in contribution to the CAMS¹ regional ensemble AQ² service (Marécal et al, 2015).

The two chains (analysis and forecasts) are operated independently: due to the timing constraints of ensemble forecasts delivery (before 7 UTC for the first 48h of forecasts), on one hand, and to the late availability of surface observations on the other hand, the AQ analysis results cannot provide initial values for the AQ forecasts.

Since July 2014, the forecast system has been running on the Météo-France operational supercomputer BULL system which is 24hours/day monitored. The MOCAGE-VALENTINA analysis chain has been operational since March 2015. ECMWF products used as boundary conditions or forcings for both chains are described in the following paragraphs:

- Meteorological initial forcings

As soon as the 00UTC or 12 UTC IFS meteorological forecasts are produced, some time critical tasks (TC3) are triggered at ECMWF to pre-process 3D field data (interpolation on the CAMS domain, on MOCAGE vertical levels and conversion to suitable format for the MOCAGE model). The result files are transferred, by ECPDS, directly to Météo France’s operational transmission system, and then automatically stored in an operational products database (BDPE). The fields used by MOCAGE are at a hourly timestep the following : pressure, temperature, humidity, wind, precipitation, nebulosity and vertical velocity.

Meanwhile, surface data from IFS 00UTC or 12 UTC forecasts are disseminated directly to the operational GRIB database at Météo France (BDAP).

The increase in MOCAGE resolution, planned for September 2018, requires (since June 2018, for testing purpose) the provision of IFS 00UTC and 12 UTC forecasts at the full resolution.

- Chemical and aerosol boundary conditions

Since November 2017, chemical and aerosol boundary conditions from C-IFS are daily and automatically transferred (through ECPDS) from ECMWF to an operational database at Météo-France. These 3-hour time step datasets are preprocessed at Météo France before use by MOCAGE assimilation or forecast systems..

- GFAS fires emission daily products

These data are retrieved from MARS, at ECMWF, and pre-processed into NETCDF files, then transferred to the storage and archiving system at Météo-France. This provision will benefit from a fully operational status at the end of 2018 with the acquisition of new hourly GFAS data

¹Copernicus Atmosphere Services

² AQ : Air Quality

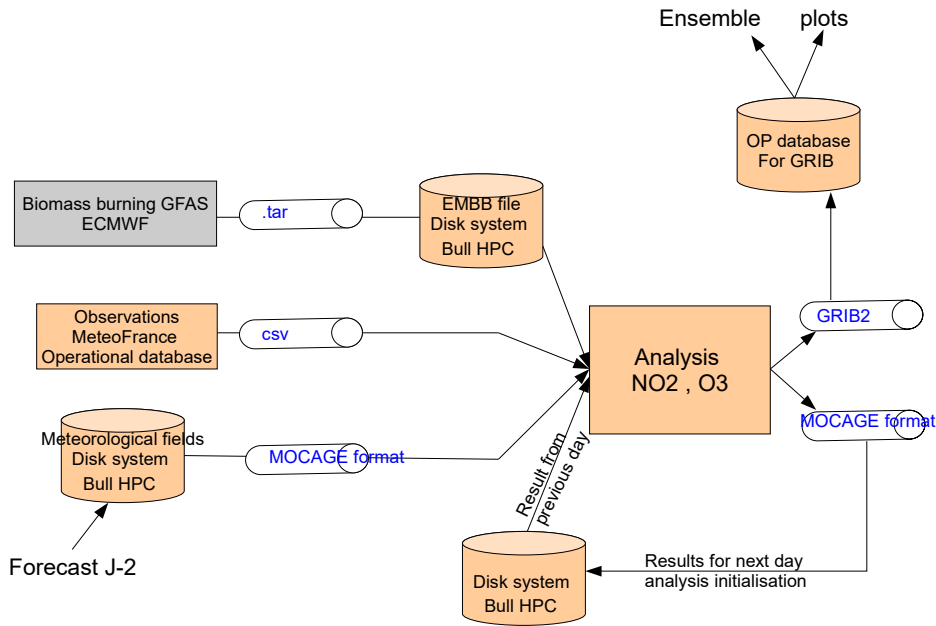

MOCAGE-VALENTINA CAMS is also operated in that context to produce interim and validated reanalyses (Reanalyses for the previous Year and for the Year-2), using the R&D HPC at Meteo-France. Boundary conditions are extracted from ECMWF using MARS system (Chemical boundary condition : depending on what has been provided by the global Copernicus system, and IFS meteorological fields).

3.1.4 End products delivered to users

3.2 Subjective verification

3.2.1 Subjective scores (including evaluation of confidence indices when available)

Monthly Forecasts of 2m temperatures have been assessed subjectively since November 2004, with a specific interest over France and nearby. The assessment is based on marks which vary from A to D with the following signification :

- A : good localisation and intensity of the anomaly,
- B : slight differences (localisation and/or intensity) between observed and forecasted anomaly,
- C : anomaly forecasted but not observed (conditions near normal) or (more frequently) anomaly observed but not forecasted (no signal in the forecast),
- D : observed anomaly opposite to the forecasted one.

The plots below show the proportion of the A+B marks (left plot) and D marks (right plot) for thursday monthly forecasts, according to the years, from 2005 to 2017.

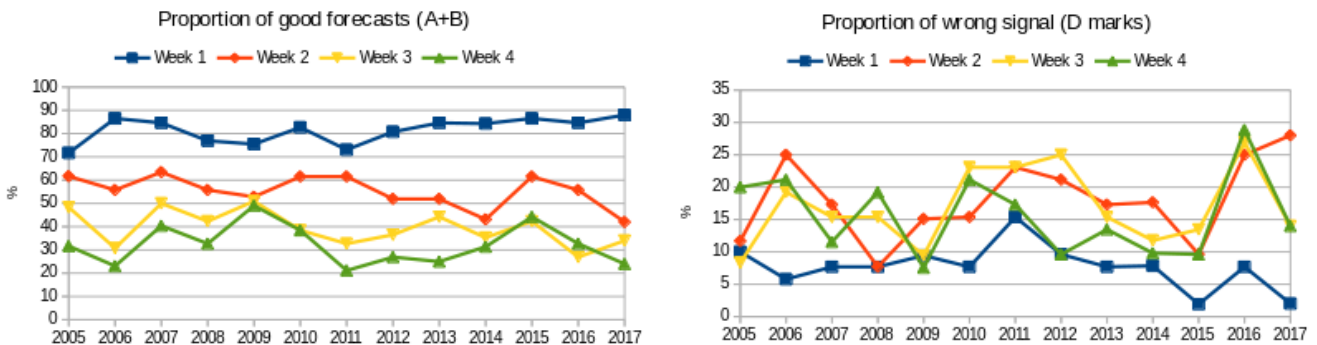

First remind that C marks are mainly cases when the forecast gives no signal, and the verification shows an anomaly, whereas D marks are cases when the forecasted anomaly is opposite to the observed one.

Left plot shows the proportion of good forecasts : week 1 is clearly much better than the others, and there is possibly a slight improvement from 2012 to 2017. We can also notice that week 3 and 4 are not very different, maybe because this time-range corresponds to the time when the atmosphere loses initial conditions memory, and also the time when there is much spread in the ensemble so the significant signals are less frequent in the forecast (so less chances to get A or B marks).

The week 2 is surprising with quite low proportion of good forecasts (50-60%). The right plot tries to explain this with the proportion of D marks (observed anomaly opposite to the forecasted one). There is a significant number of D marks (15-25%) for week 2, roughly the same proportion as week 3 and 4. For week 3 and 4 there are much less cases with significant signal, so the risk of D mark is lower. Nevertheless, the proportion of ~20% of opposite signal for week 2 is questionable. The study of these cases could help improve the medium and extended range forecasts.

3.2.2 Case studies

The storm "Ana" happened on December 10th and 11th causing heavy rain and snow in the mountains. Gusts of wind reached locally 110 kph in lands and 130 kph on coast with a maximum of 161 kph on the île de Ré. At a national level, 9 % of the territory was impacted by winds superior to 100 kph. NWP models had difficulties forecasting the storm trajectory and wind gusts were too far in the South on arrival on the Atlantic Coast at 6hTU for both models :

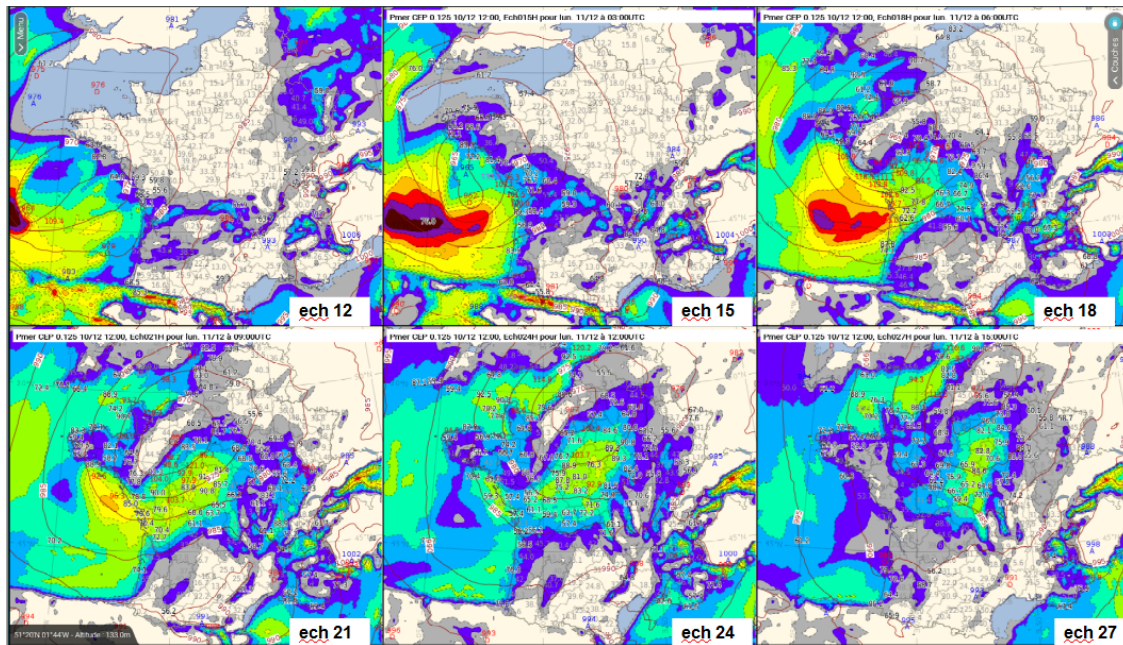

Fig 6: Mean Sea Level Pressure and wind gusts for ECMWF-IFS Storm ANA - December 11th 2017 Forecasted on December 10th at 12hUTC for the next day from 00hUTC to 15hUTC

Best forecasts were obtained with AROME-ECMWF, the 10th December for the next day :

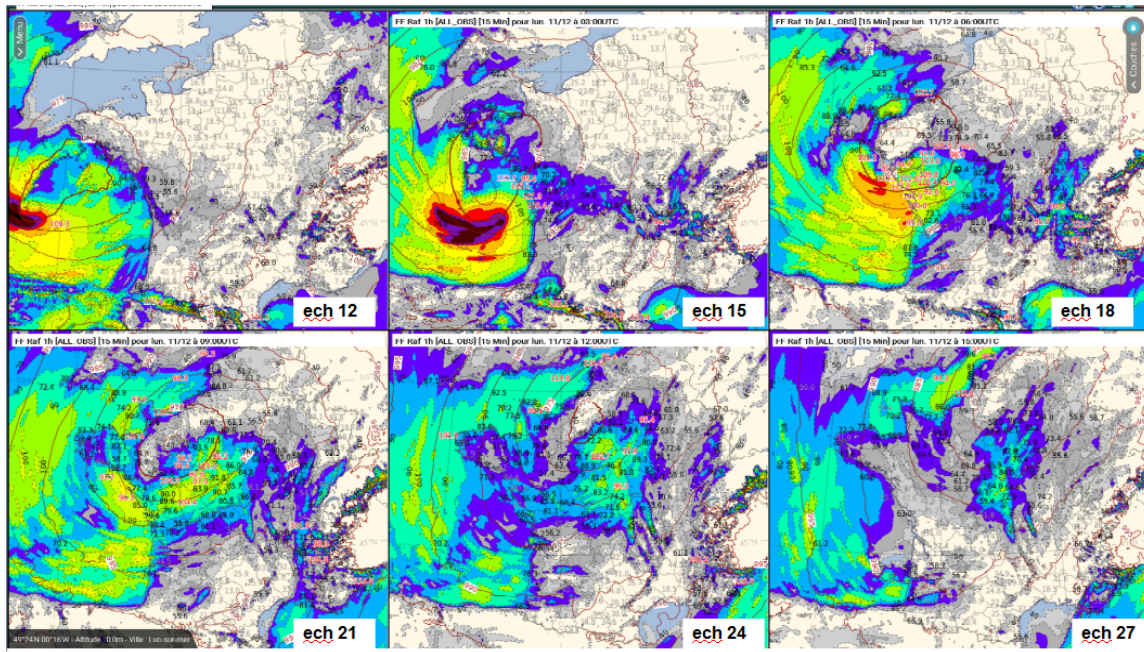

Fig 7: Mean Sea Level Pressure and wind gusts for AROME-ECMWF Storm ANA - December 11th 2017 Forecasted on December 10th at 12hUTC for the next day from 00hUTC to 15hUTC

4. Feedback on ECMWF “forecast user” initiatives

5. References to relevant publications

Marécal, V. *etal.*, 2015: A regional air quality forecasting system over Europe: the MACC-II daily ensemble production, *Geosci. Model Dev.*, **8**, 2777-2813, doi:10.5194/gmd-8-2777-2015, 2015.

Taillardat, M., Mestre, O., Zamo, M., & Naveau, P. (2016). Calibrated ensemble forecasts using quantile regression forests and ensemble model output statistics. *Monthly Weather Review*, 144(6), 2375-2393.

Wintenberger, O. (2017). Optimal learning with Bernstein online aggregation. *Machine Learning*, 106(1), 119-141.

Zamo, M., 2016: Statistical Post-processing of Deterministic and Ensemble Wind Speed Forecasts on a Grid, *Paris-Saclay University Phd thesis NNT : 2016SACLA029*